

REV.	ECN NO.	MODIFIED MARK	APPROVED
A	—	FIRST RELEASE	

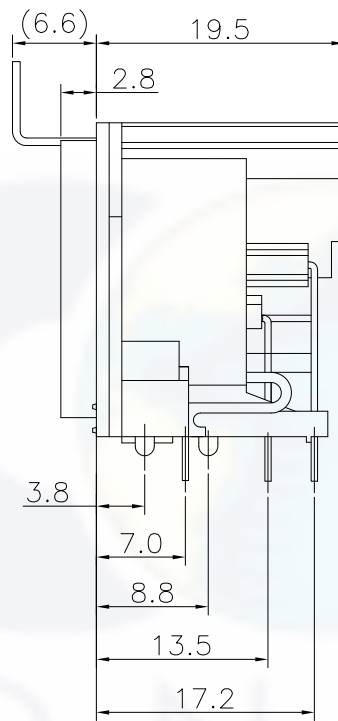

NOTES:
 ELECTRICAL:
 1:RATED CURRENT: 3A Max.
 2:RATED VOLTAGE: 50V AC.
 3:CONTACT RESISTANCE: 30 MILLIOHMS Max.
 AFTER TESTING:60 MILLIOHMS Max.
 4:INSULATION RESISTANCE: 1G OHMS Min.
 5:DIELECTRIC WITHSTANDING VOLTAGE: 500 VAC Min.
 MECHANICAL:
 1:INSERTION FORCE: 5N-40N.
 2:WITHDRAWAL FORCE: 5N-40N.
 3:DURRABILITY: 1000 CYCLES.
 ENVIRONMENTAL:
 TEMPERATURE RANGE: -30°C TO 80°C.

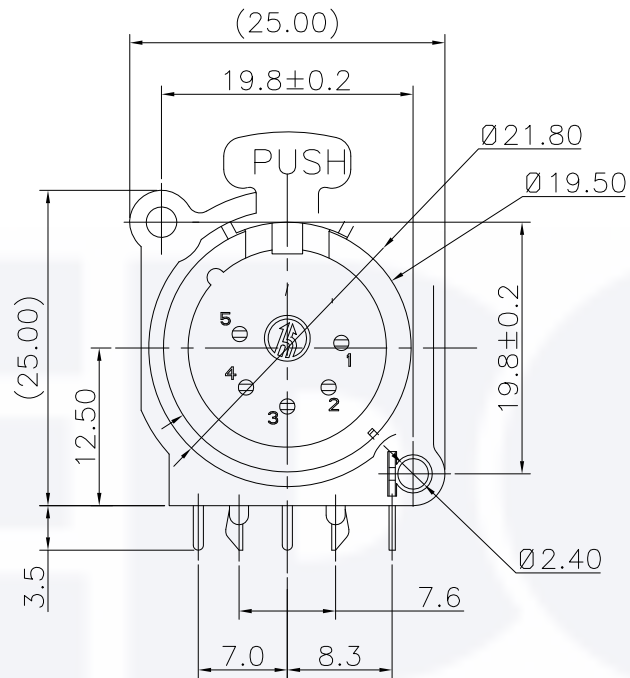
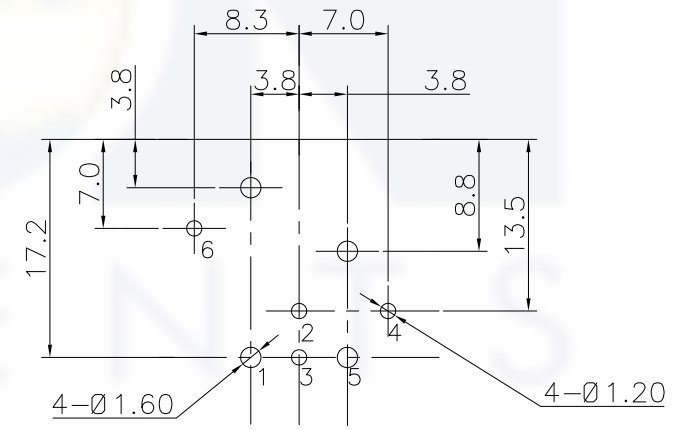

PCB LAYOUT
TOP VIEW

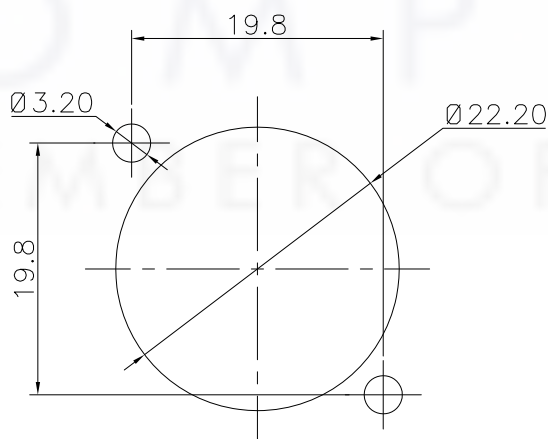

PANEL CUTOUT

ANGLE	±5°
63 < L	±0.5
16 < L ≤ 63	±0.4
4 < L ≤ 16	±0.3
L ≤ 4	±0.2
TOL TABLE:	
THIS DOCUMENT IS THE PROPERTY OF TRENPRO TECHNOLOGY CO. LTD.,NO PART THEREOF MAY BE REPRODUCED AND USED WITHOUT THE PRIOR WRITTEN CONSENT OF THE OWNER	

MODEL NAME: T74006 (PART NO.)		TITLE: XLR CABLE CONNECTORS	
MAT'L: See table	DESIGN: X.H.Wang 08/31'18	DWG NO.:	
FINISH: See table	CHECKED: L.W.Wu 08/31'18	REV.: A	
Q'TY: /	APPROVED: X.Q.Hu 08/31'18	UNIT: mm	VIEW:
		SCALE: 5:1	SHEET: 1/1
		SIZE: A3	