

# EDCON-COMPONENTS



## SPECIFICATION:

Voltage Rating:	42V
Current Rating:	100mA
Contact Resistance:	≤100mΩ MAX.
Insulation Resistance:	≥ 100MΩ MIN.
Operating Force:	250gf max
Lifetime Cycles:	20000 cycles
Operating Temperature:	.-25°C to +85°C
Solder Condtion:	Reflow Soldering :10s/260°C
	Iron Soldering: 4s/350°C
	Wave Soldering: 5s/280°C

## P.C.B Layout

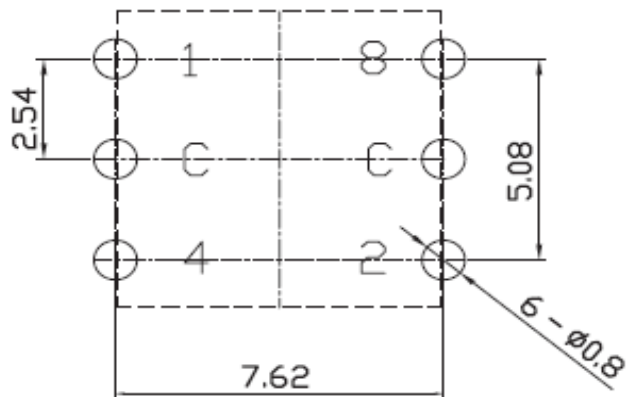

## Drawing

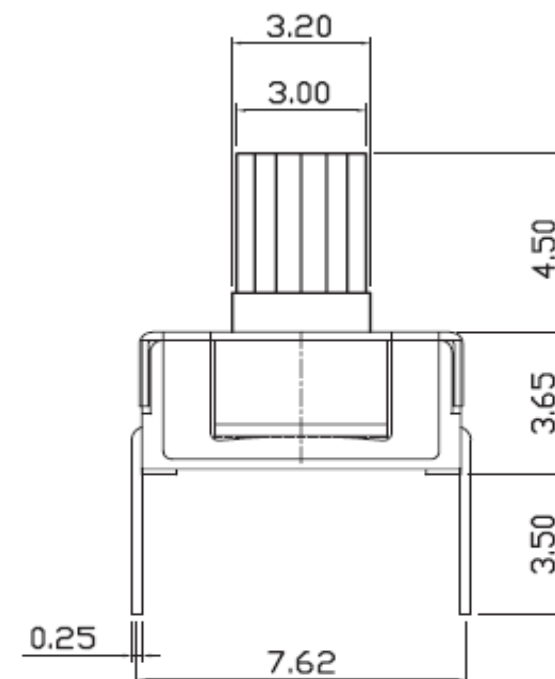
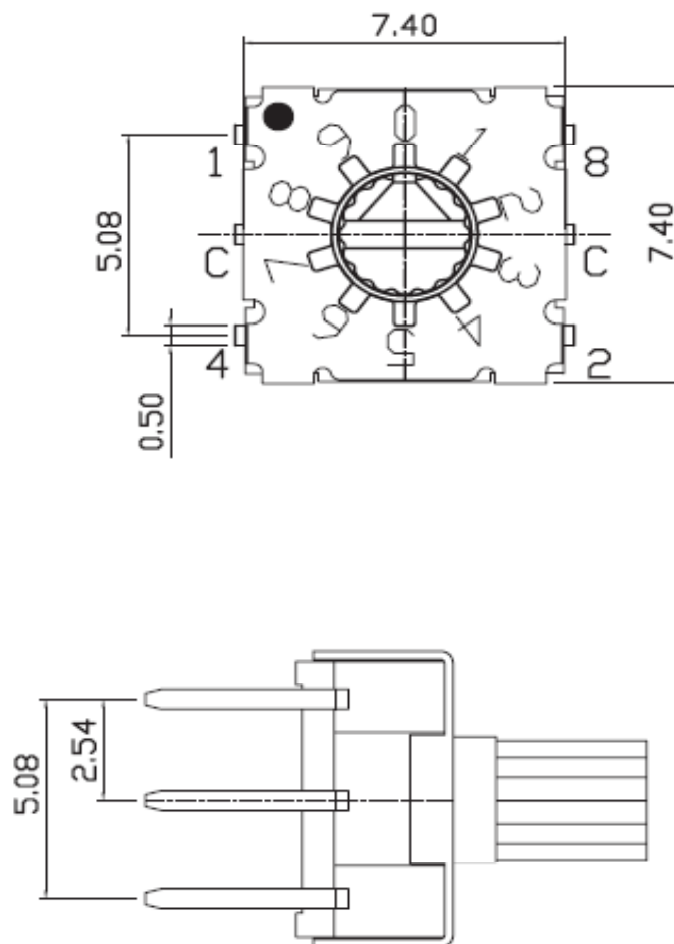

Rotary BCD-Switch  
7,4x7,4mm

Part No.: **Q27048**

Customer:

DRW:	Jason	CHKD	Wilson	MATL:	Wilson	TOLERANCE	Mason	DATE	31.07.2021
APPD:	Schumi			FINISH	Jamy		Sheet No.	1 from 2	

# EDCON-COMPONENTS



## Ordering Informations

Serie	Total height w. Body	Special function	Special function	ROHS	Packing				
<b>Q27048</b>	<b>10R</b>	<b>N</b>	<b>N</b>	<b>R</b>	<b>TU</b>				

<b>10R</b> = 10Pos. Real Code	<b>N</b> = No Special function	<b>N</b> = No Special function	<b>N</b> = non ROHS	<b>BU</b> = Bulk Ware
<b>16R</b> = 16Pos. Real Code			<b>R</b> = ROHS conform	<b>TY</b> = Tray Packing
				<b>TR102</b> = Tape/Reel Packing 1000PCS

		Real Coded				
		C	1	2	4	8
10 P o s i t i o n	0	●				
	1	●	●			
	2	●		●		
	3	●	●	●		
	4	●			●	
	5	●	●		●	
	6	●		●	●	
	7	●	●	●	●	
	8	●				●
	9	●	●			●
16 P o s i t i o n	A	●		●		●
	B	●	●	●		●
	C	●			●	●
	D	●	●		●	●
	E	●		●	●	●
	F	●	●	●	●	●

Rotary BCD-Switch 7,4x7,4mm	
Part No.:	<b>Q27048</b>
Customer:	

DRW:	Jason	CHKD	Wilson	MATL:	Wilson	TOLERANCE	Mason	DATE	31.07.2021
APPD:	Schumi			FINISH	Jamy		Sheet No.		2 from 2