

EDCON-COMPONENTS

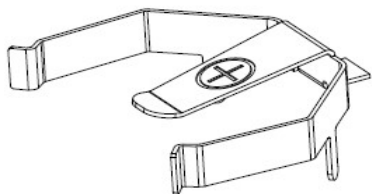

Technical Drawing (mm)

PCB-PAD-Layout (mm)

Technical Specification

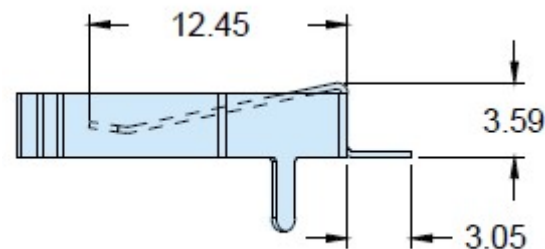
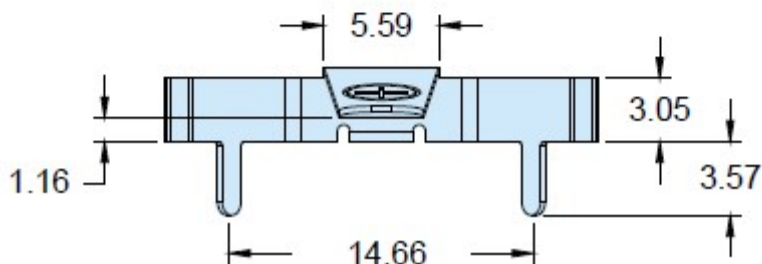
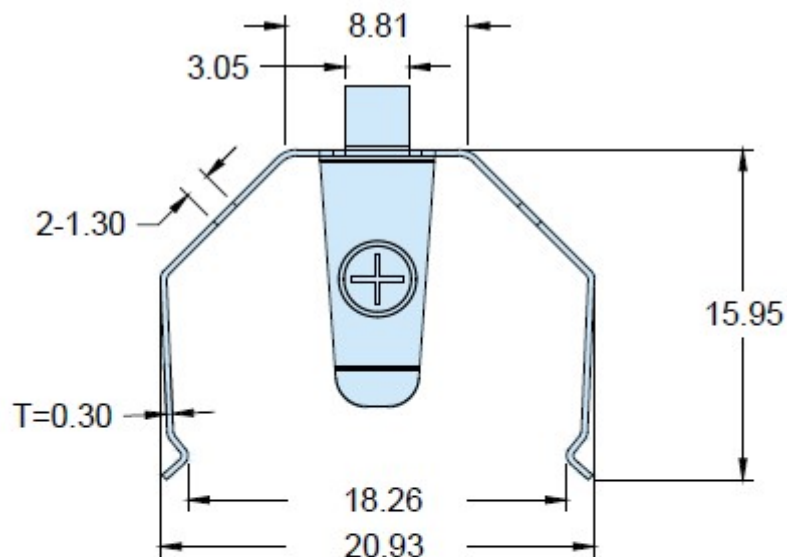

Material:	Phosphor Bronze
Finish/Plating:	Matte Tin / Ni-Plated
Contact Resistance:	low contact resistance
Mechanical Durability:	>100Cycles
Operating Temperature:	-.40°c to +105°C

Reliable spring tension assures low contact resistance

Retains battery securely to withstand shock and vibration

Ideal for high Density Packing

The most off parts available into SMD and THT

Mating for Battery Type:

CR2032

Coin Cell Holder for Battery Ø 20mm

Part No.: **B23176**

Customer:

DRW:	Jason	CHKD	Wilson	MATL:	Wilson	TOLERANCE	Mason	DATE	28.01.2023
APPD:	Schumi			FINISH	Jamy		Sheet No. CCR-2033		1 from 3

www.edcon-components.com

email: info@edcon-components.com

EDCON-COMPONENTS

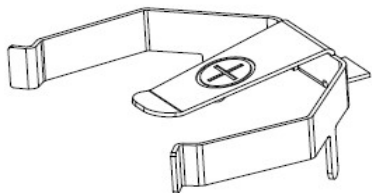

Ordering Informations

Serie	Contact Plating	Spezial Function	Spezial Function	Spezial Function	ROHS	Packing				
B23176	NI	0	0	0	R	BU				

NI= Nickel-Plated	0= No function	0= No function	0= No function	R= ROHS Conform	BU= Bulk-Ware
MN= Matte Tin-Plated					

Coin Cell Holder for Battery Ø 20mm	
Part No.:	B23176
Customer:	

DRW:	Jason	CHKD	Wilson	MATL:	Wilson	TOLERANCE	Mason	DATE	28.01.2023
APPD:	Schumi			FINISH	Jamy				2 from 3

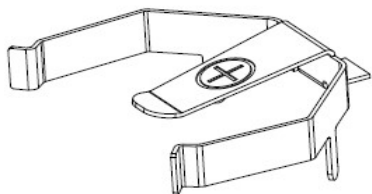

Soldering Profile Curve

Classification Reflow Profile (JEDEC J-STD-020C)

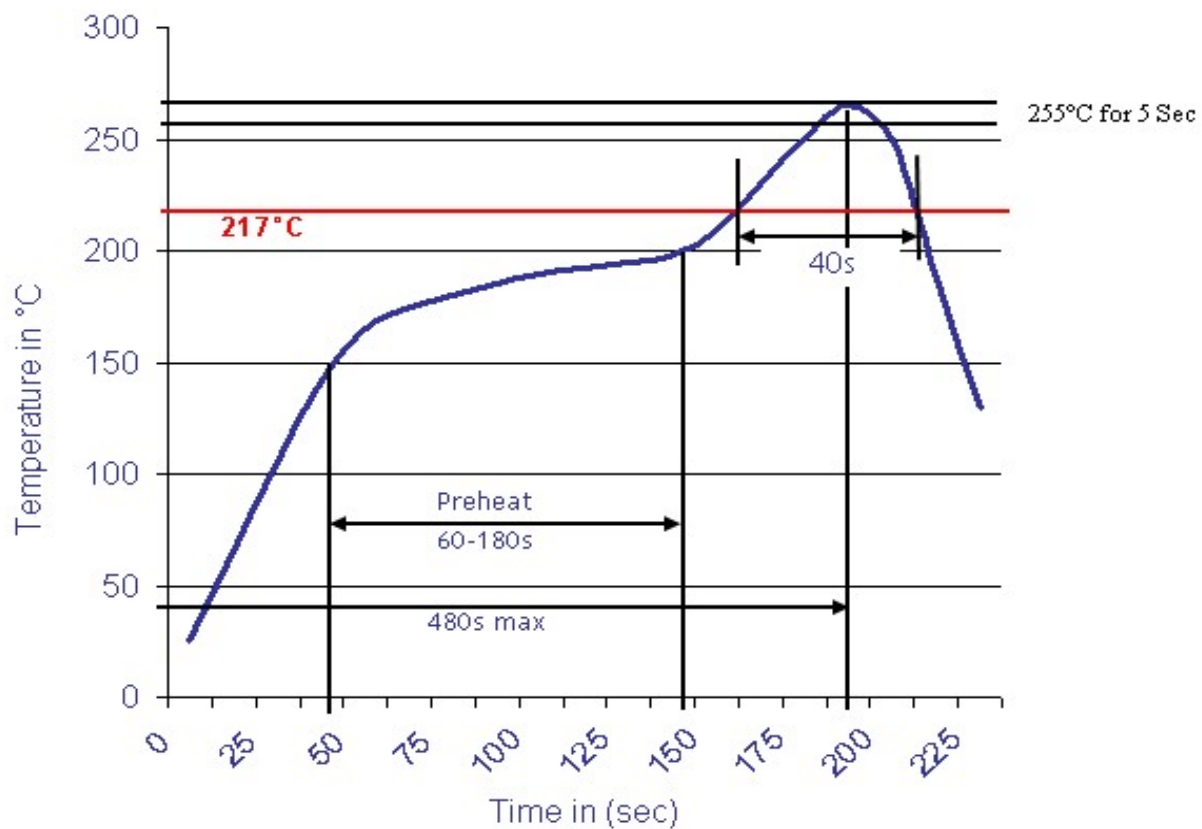

Coin Cell Holder for Battery Ø 20mm	
Part No.:	B23176
Customer:	

DRW:	Jason	CHKD:	Wilson	MATL:	Wilson	TOLERANCE:	Mason	DATE:	28.01.2023
APPD:	Schumi			FINISH:	Jamy		Sheet No.		3 from 3