

EDCON-COMPONENTS

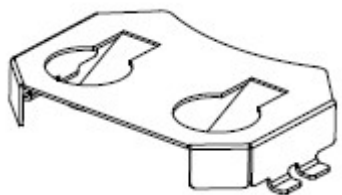

Technical Drawing (mm)

PCB-PAD-Layout (mm)

Technical Specification

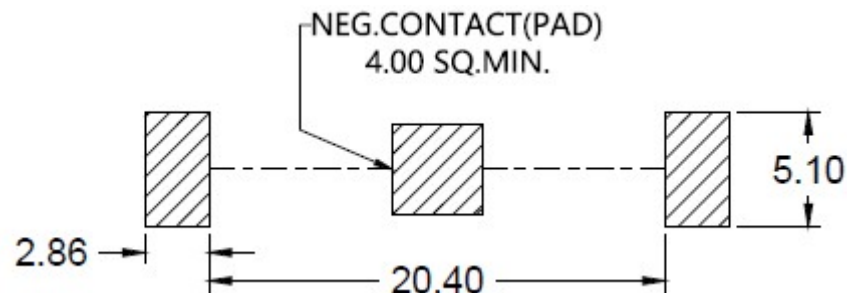
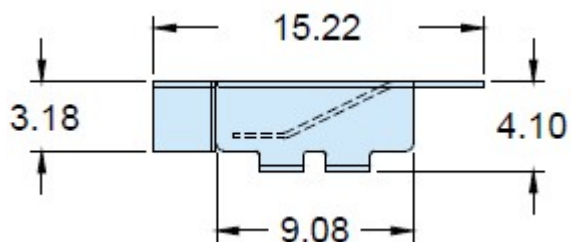

Material: Phosphor Bronze
 Finish/Plating: Matte Tin / Ni-Plated
 Contact Resistance: low contact resistance
 Mechanical Durability: >100Cycles
 Operating Temperature: -40°C to +105°C

Reliable spring tension assures low contact resistance

Retains battery securely to withstand shock and vibration
 Ideal for high Density Packing
 The most off parts available into SMD and THT

Mating for Battery Type:
CR2025, CR2032

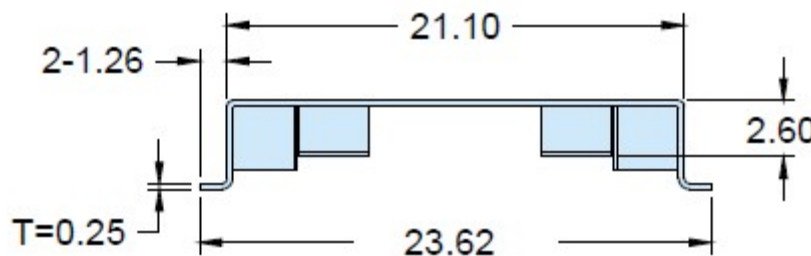
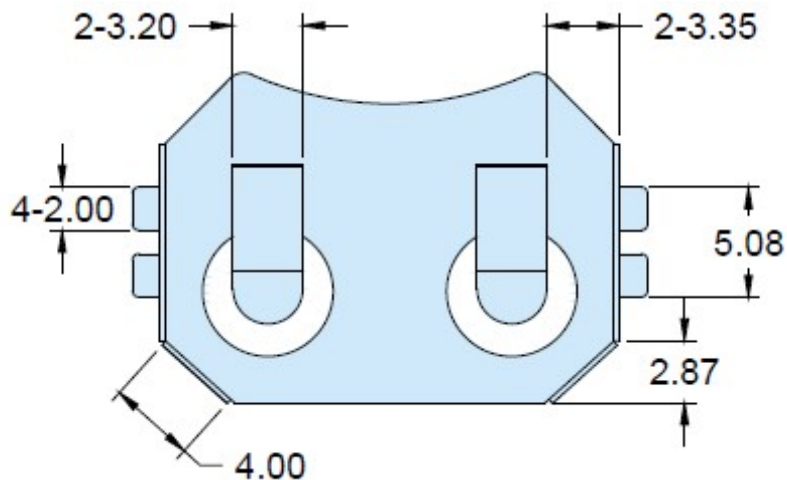

Coin Cell Holder for Battery Ø 20mm	
Part No.:	B23172
Customer:	

DRW:	Jason	CHKD:	Wilson	MATL:	Wilson	TOLERANCE:	Mason	DATE:	28.01.2023
APPD:	Schumi	FINISH:	Jamy				Sheet No. CCR-2028		1 from 3

www.edcon-components.com

email: info@edcon-components.com

EDCON-COMPONENTS

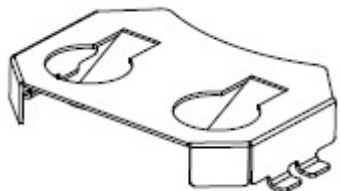

Ordering Informations

Serie	Contact Plating	Spezial Function	Spezial Function	Spezial Function	ROHS	Packing				
B23172	NI	0	0	0	R	BU				

NI = Nickel-Plated	0 = No function	0 = No function	0 = No function	R = ROHS Conform	BU = Bulk-Ware
MN = Matte Tin-Plated					TR = Tape Reel

Coin Cell Holder for Battery Ø 20mm
Part No.: B23172
Customer:

DRW:	Jason	CHKD	Wilson	MATL:	Wilson	TOLERANCE	Mason	DATE	28.01.2023
APPD:	Schumi			FINISH	Jamy				2 from 3

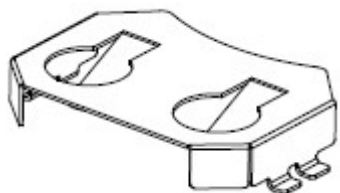

Soldering Profile Curve

Classification Reflow Profile (JEDEC J-STD-020C)

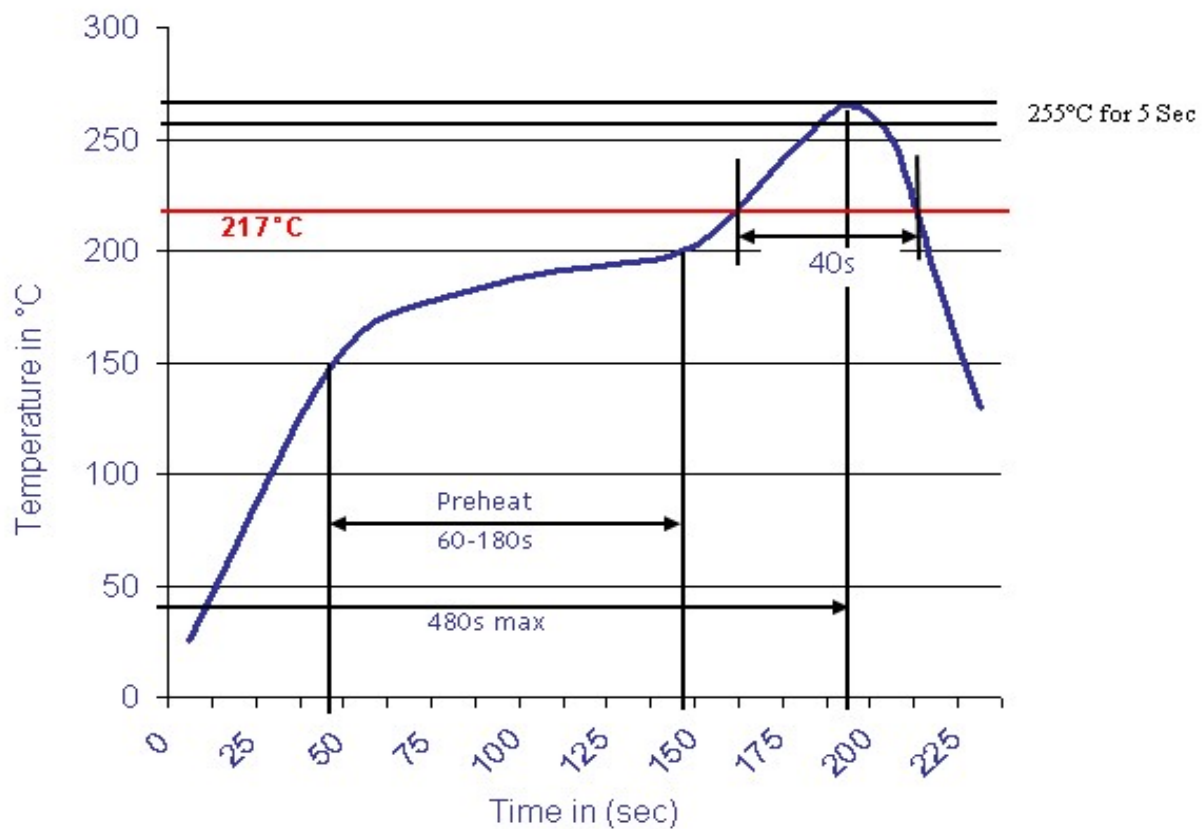

Coin Cell Holder for Battery Ø 20mm	
Part No.:	B23172
Customer:	

DRW:	Jason	CHKD:	Wilson	MATL:	Wilson	TOLERANCE:	Mason	DATE:	28.01.2023
APPD:	Schumi			FINISH:	Jamy		Sheet No.		3 from 3