

# EDCON-COMPONENTS

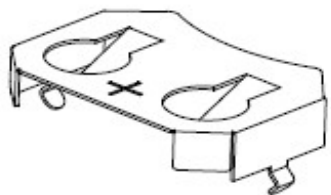

Technical Drawing (mm)

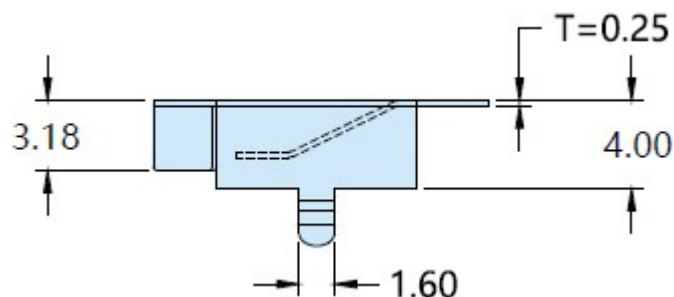

PCB-PAD-Layout (mm)

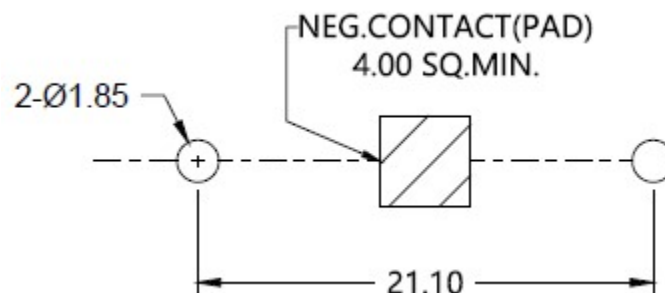

Technical Specification

|   |                        |
|---|------------------------|
| Material:   | Phosphor Bronze        |
| Finish/Plating:   | Matte Tin / Ni-Plated  |
| Contact Resistance:                                       | low contact resistance |
| Mechanical Durability:                                    | >100Cycles             |
| Operating Temperature:                                    | -.40°C to +105°C       |
| Reliable spring tension assures low contact resistance    |                        |
| Retains battery securely to withstand shock and vibration |                        |
| Ideal for high Density Packing                            |                        |
| The most off parts available into SMD and THT             |                        |
| <b>Mating for Battery Type:</b>                           |                        |
| <b>CR2025, CR2032</b>                                     |                        |

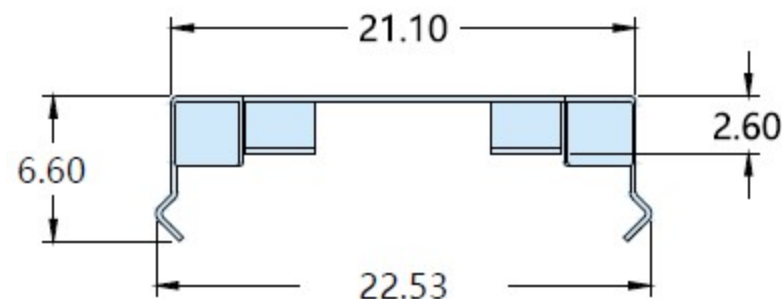
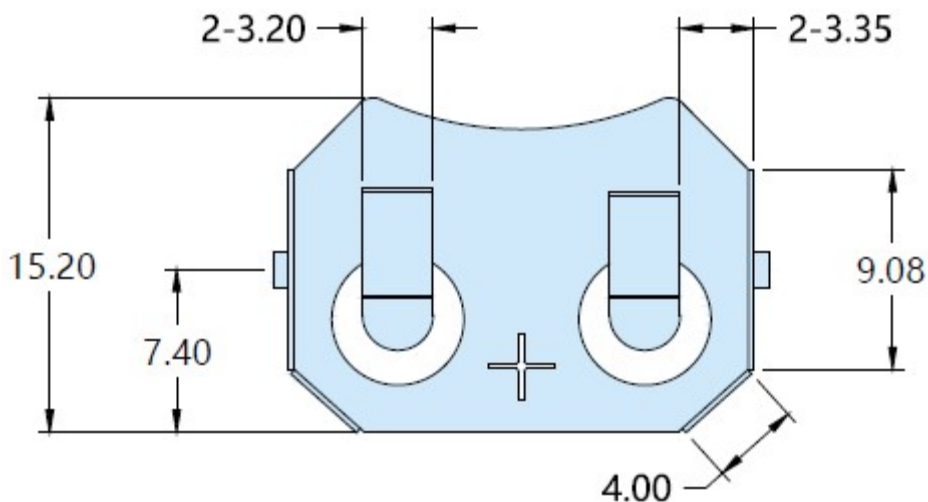

|  |               |
|--|---------------|
| <b>Coin Cell Holder for Battery Ø 20mm</b> |               |
| Part No.:                                  | <b>B23169</b> |
| Customer:                                  |               |

|       |        |      |        |        |        |           |                    |      |            |
|-------|--------|------|--------|--------|--------|-----------|--------------------|------|------------|
| DRW:  | Jason  | CHKD | Wilson | MATL:  | Wilson | TOLERANCE | Mason              | DATE | 28.01.2023 |
| APPD: | Schumi |      |        | FINISH | Jamy   |           | Sheet No. CCR-2005 |      | 1 from 3   |

[www.edcon-components.com](http://www.edcon-components.com)

email: [info@edcon-components.com](mailto:info@edcon-components.com)

# EDCON-COMPONENTS

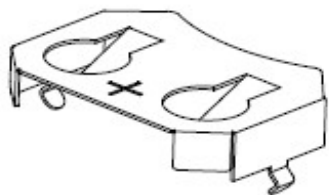

## Ordering Informations

| Serie         | Contact Plating | Spezial Function | Spezial Function | Spezial Function | ROHS     | Packing   |  |  |  |  |
|---------------|-----------------|------------------|------------------|------------------|----------|-----------|--|--|--|--|
| <b>B23169</b> | <b>NI</b>       | <b>0</b>         | <b>0</b>         | <b>0</b>         | <b>R</b> | <b>BU</b> |  |  |  |  |

|                              |                        |                        |                        |                         |                       |
|------------------------------|------------------------|------------------------|------------------------|-------------------------|-----------------------|
| <b>NI</b> = Nickel-Plated    | <b>0</b> = No function | <b>0</b> = No function | <b>0</b> = No function | <b>R</b> = ROHS Conform | <b>BU</b> = Bulk-Ware |
| <b>MN</b> = Matte Tin-Plated |                        |                        |                        |                         |                       |
|                              |                        |                        |                        |                         |                       |

|  |               |
|--|---------------|
| <b>Coin Cell Holder for<br/>Battery Ø 20mm</b> |               |
| Part No.:                                      | <b>B23169</b> |
| Customer:                                      |               |

|       |        |      |        |        |        |           |       |      |            |
|-------|--------|------|--------|--------|--------|-----------|-------|------|------------|
| DRW:  | Jason  | CHKD | Wilson | MATL:  | Wilson | TOLERANCE | Mason | DATE | 28.01.2023 |
| APPD: | Schumi |      |        | FINISH | Jamy   |           |       |      | 2 from 3   |

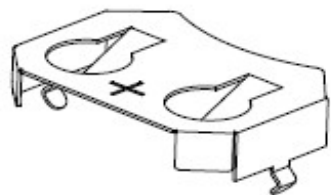

Soldering Profile Curve

Classification Reflow Profile (JEDEC J-STD-020C)

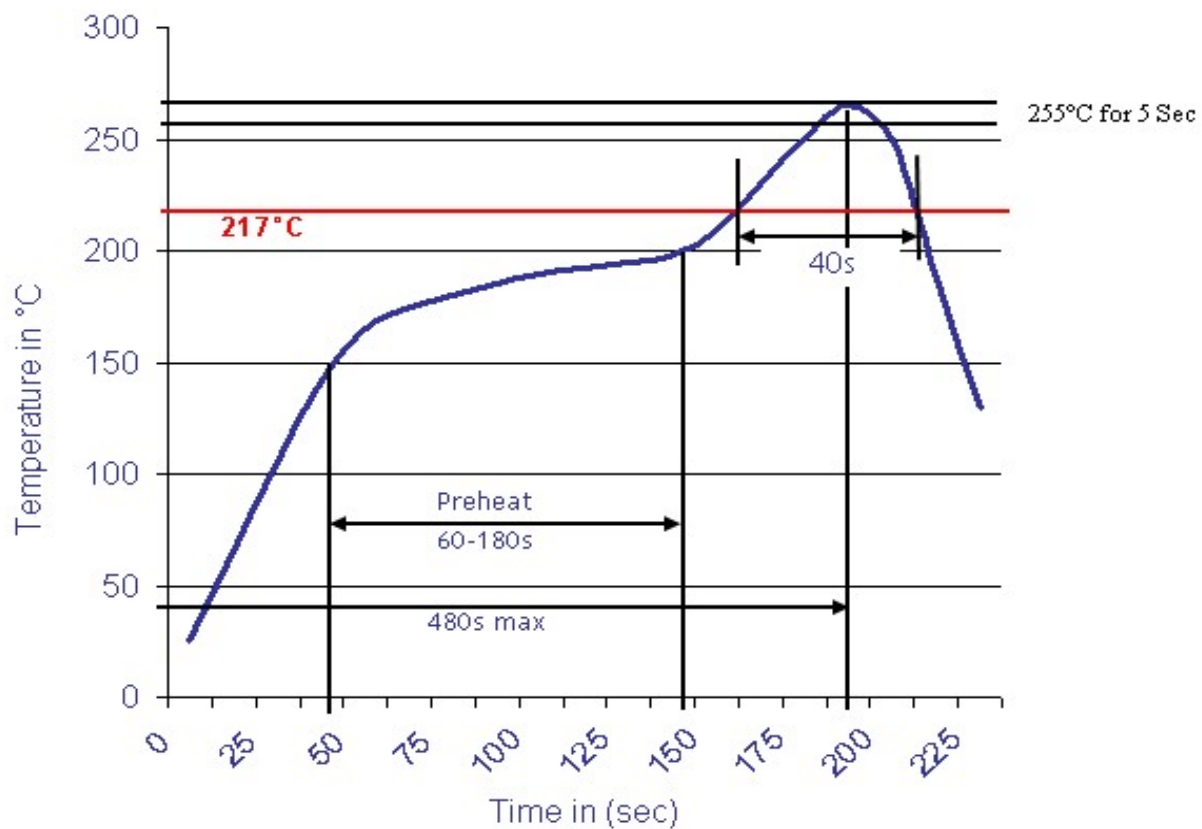

|  |               |
|--|---------------|
| <b>Coin Cell Holder for Battery Ø 20mm</b> |               |
| Part No.:                                  | <b>B23169</b> |
| Customer:                                  |               |

|       |        |         |        |       |        |            |       |       |            |
|-------|--------|---------|--------|-------|--------|------------|-------|-------|------------|
| DRW:  | Jason  | CHKD:   | Wilson | MATL: | Wilson | TOLERANCE: | Mason | DATE: | 28.01.2023 |
| APPD: | Schumi | FINISH: | Jamy   |       |        | Sheet No.: |       |       | 3 from 3   |