



DATA SHEET

SMD 7P + 15P SATA-Connector SIDE-Entry SINK-TYPE

Serie: T12012

**SMD 7P + 15P SATA-Connector
SIDE-Entry SINK-TYPE**

Serie No.: **T12012**

DRW:	Jason	CHKD	Wilson	MATL:	Wilson	TOLERANCE	Mason	DATE	18.03.2018	Customer:
APPD:	Schumi			FINISH	Jamy		Sheet No.	1 from 5		



Technical Description

Material Housing:	LCP (UL94V-0)
Colour of Body:	Black
Contact Material:	Phosphor Bronze 0,25mm C5191
Board Lock Material:	Brass C2680,
Contact Plating:	Gold Flash on Contact Area Tin plating on Soldering Area over Nickel
Lifetime:	500cycles
Current Rating:	1,5A
Voltage Rating:	40VAC
Contact Resistance:	30mΩ max.
Withstanding Voltage:	500VAC
Resistance:	1000MΩ min.
Temperature Range:	-20°C to + 85°C

Technical Drawing (mm)

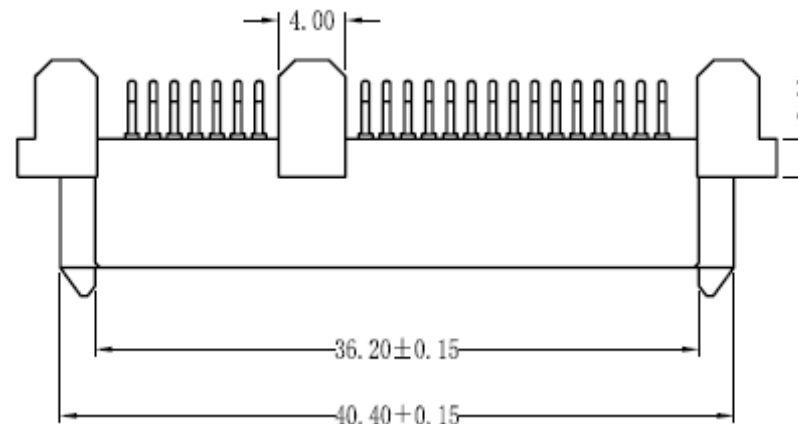

PCB Layout (mm)

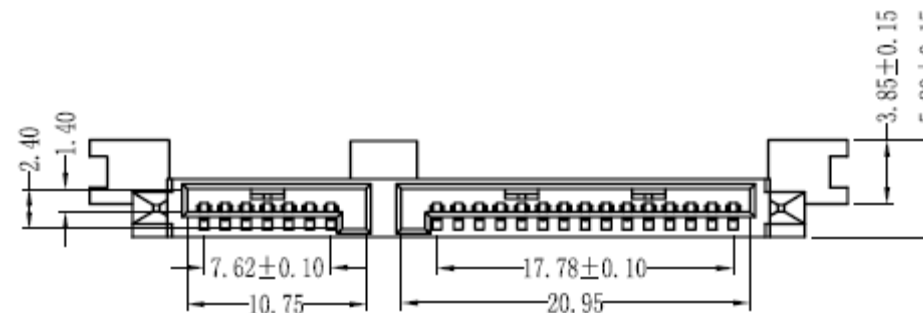
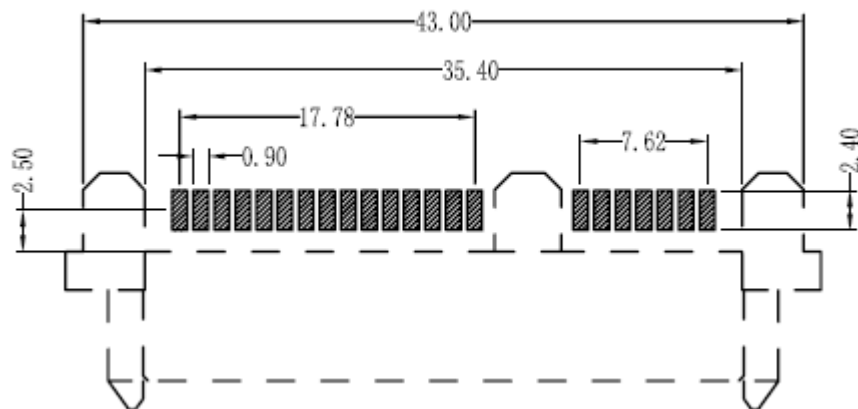

**SMD 7P + 15P SATA-Connector
SIDE-Entry SINK-TYPE**

Part No.: **T12012**

Customer:

DRW:	Jason	CHKD	Wilson	MATL:	Wilson	TOLERANCE	Mason	DATE	18.03.2018
APPD:	Schumi			FINISH	Jamy		Sheet No.		2 from 5

EDCON-COMPONENTS



Technical Drawing (mm)

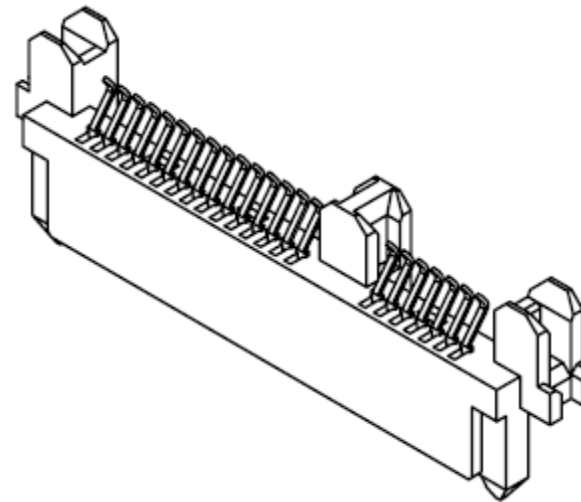
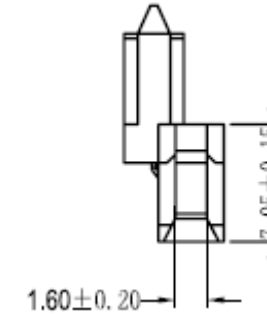
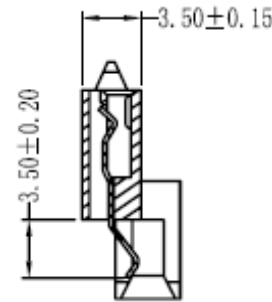
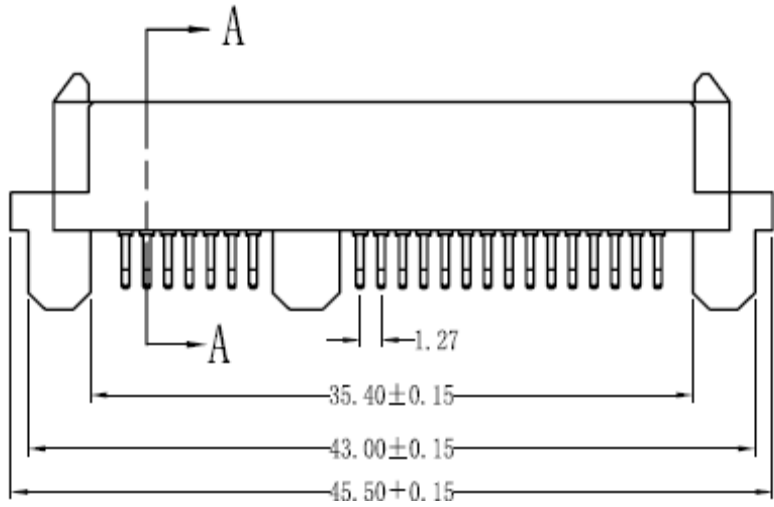

**SMD 7P + 15P SATA-Connector
SIDE-Entry SINK-TYPE**

Part No.: **T12012**

Customer:

DRW:	Jason	CHKD	Wilson	MATL:	Wilson	TOLERANCE	Mason	DATE	18.03.2018
APPD:	Schumi			FINISH	Jamy		Sheet No.		3 from 5

EDCON-COMPONENTS



Ordering Informations

Customer	Connector No of Pos 1	Connector No of Pos 2	Contact Plating	Body Colour	Body Material	Special function	ROHS	Packing Code		
----------	-----------------------	-----------------------	-----------------	-------------	---------------	------------------	------	--------------	--	--

T12012	7	15	G0	BK	LC	N	R	TY		
---------------	----------	-----------	-----------	-----------	-----------	----------	----------	-----------	--	--

7= 7Pos. of Contact		G0= Gold Flash	BK= Black	LC= LCP	N= No special function	R= ROHS Conform	TY= Tray Package
		GA= 5µ Gold Flash				N= NON ROHS Conform	TR= Tape/Reel Package
	15= 15Pos. of Contact	GB= 10µ Gold Flash					TC= Tape/Reel w. Pic and Place CAP Package TOP-SIDE
							IV= Individual Package

**SMD 7P + 15P SATA-Connector
SIDE-Entry SINK-TYPE**

Part No.: **T12012**

DRW:	Jason	CHKD	Wilson	MATL:	Wilson	TOLERANCE	Mason	DATE	18.03.2018
APPD:	Schumi			FINISH	Jamy		Sheet No.		4 from 5

Customer:



Soldering Profile Curve

Classification Reflow Profile (JEDEC J-STD-020C)

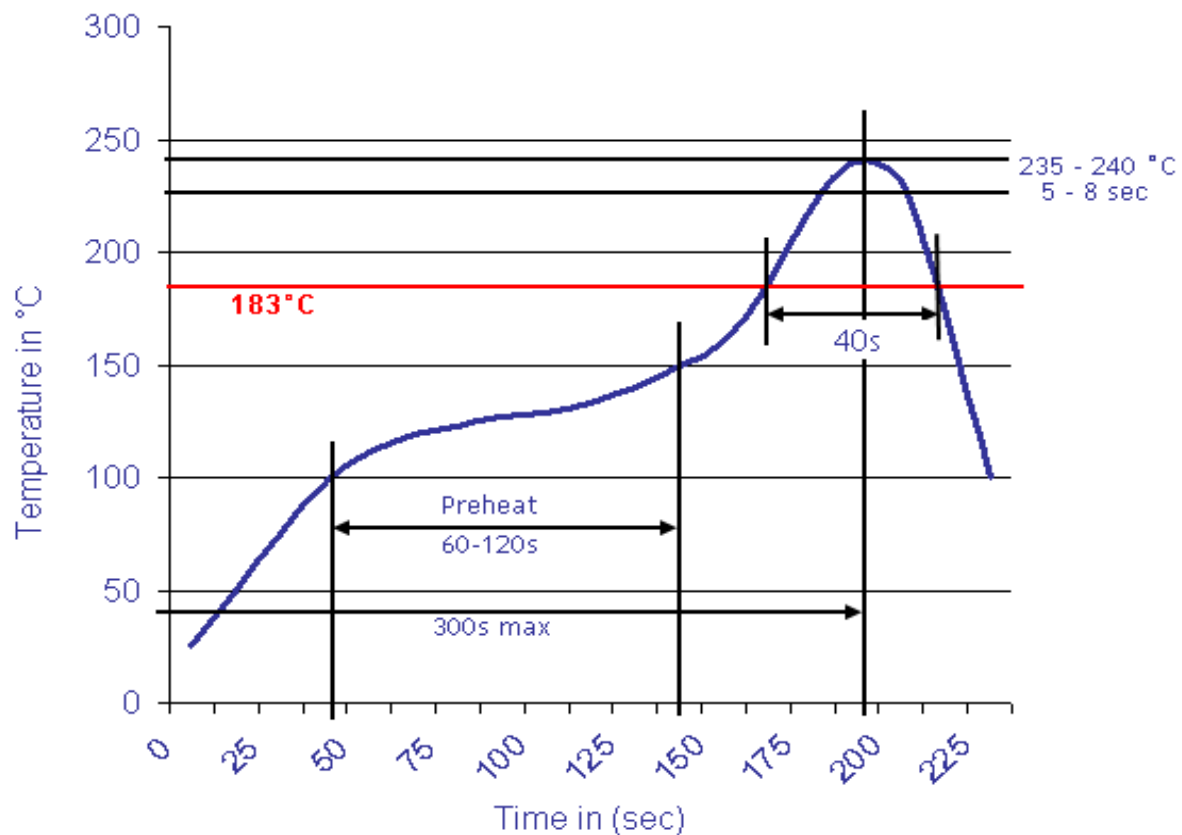

SMD 7P + 15P SATA-Connector SIDE-Entry SINK-TYPE	
Part No.:	T12012
Customer:	

DRW:	Jason	CHKD	Wilson	MATL:	Wilson	TOLERANCE	Mason	DATE	18.03.2018
APPD:	Schumi			FINISH	Jamy		Sheet No.		5 from 5