

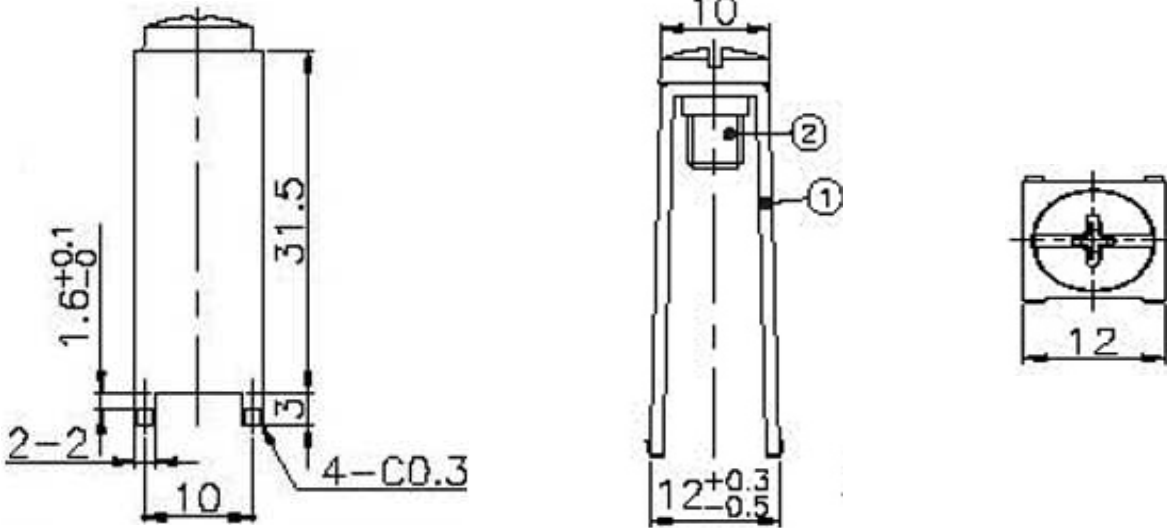

Technical Dimension



Material

Material: Brass, Tin plated
 Screw: M5
 Material Screw: Brass, Nickel Plated
 Rated Current: 40A

PCB Board Drawing

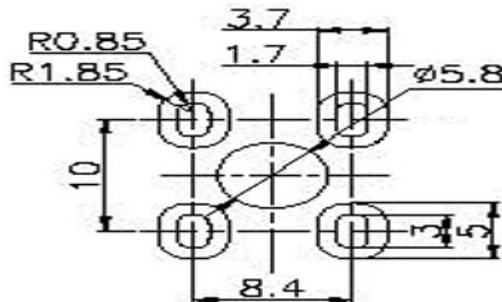

Ordering Information

Serie	Material	Surface	Screw	Special	ROHS	Packing
A25065	BR	TN	NO	M5	R	BU

BR= Brass	TN= Tin plated	NO= Screw Not Mounted	M5= Screw size	R= ROHS Conform	BU= Bulk Ware
		YE= Screw Fixed on Terminal		N= NON ROHS	

PCB Power Terminal

Part No.: **A25065**

Customer:

DRW:	Jason	CHKD	Jules	MATL:	Wu	DATE	17.11.2017
APPD:	Join			FINISH	Shieh	Sheet	1 from 1