

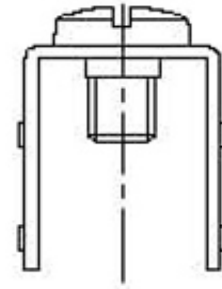

Technical Dimension

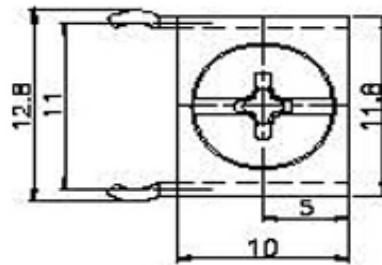
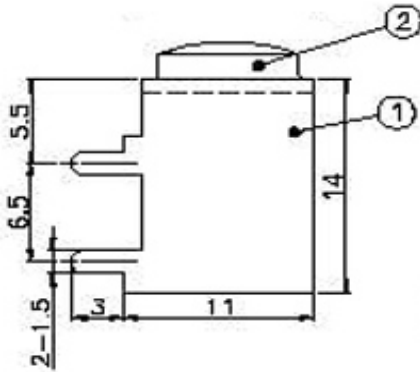

Material

Material: Brass, Tin plated
 Screw: M4
 Material Screw: Brass
 Rated Current: 20A

PCB Board Drawing

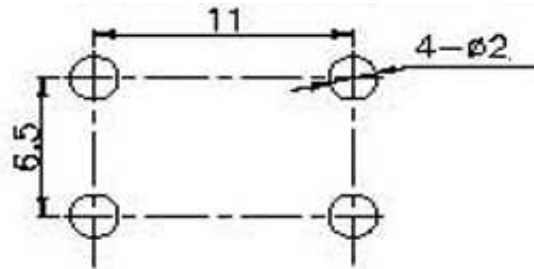

Ordering Information

Serie	Material	Surface	Screw	Special	ROHS	Packing
A25053	BR	TN	NO	M4	R	BU

BR= Brass	TN= Tin plated	NO= Screw Not Mounted	M4= Screw size	R= ROHS Conform	BU= Bulk Ware
	NI= Nickel plated	YE= Screw Fixed on Terminal		N= NON ROHS	

PCB Power Terminal

Part No.: **A25053**

Customer:

DRW:	Jason	CHKD	Jules	MATL:	Wu	DATE	17.11.2017
APPD:	Join			FINISH	Shieh	Sheet	1 from 1