

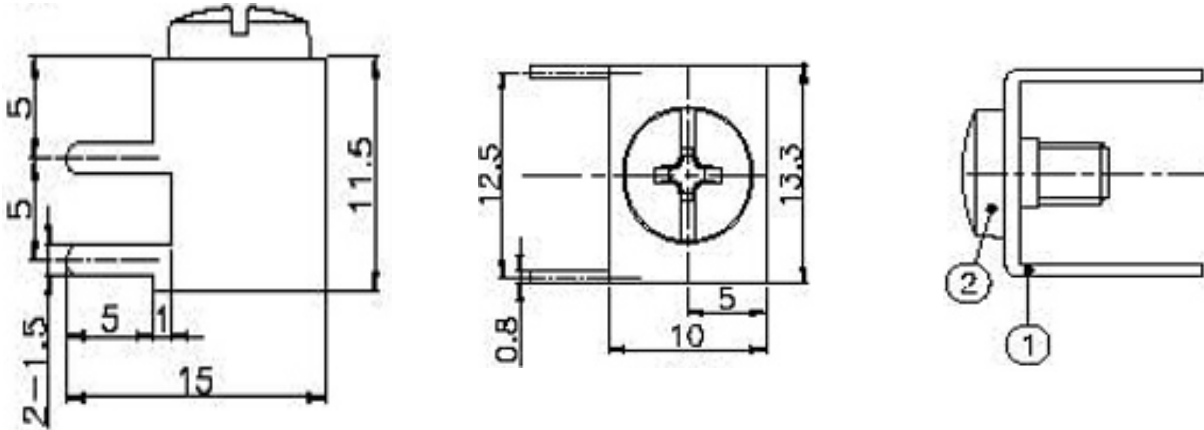

**Technical Dimension**



**Material**

Material: Brass, Tin plated  
 Screw: M4  
 Material Screw: Brass  
 Rated Current: 20A

**PCB Board Drawing**

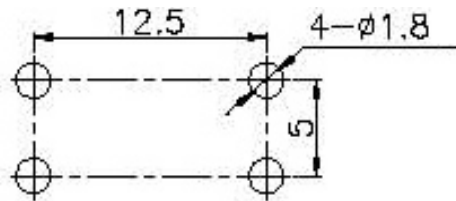

**Ordering Information**

Serie	Material	Surface	Screw	Special	ROHS	Packing
<b>A25047</b>	<b>BR</b>	<b>TN</b>	<b>NO</b>	<b>M4</b>	<b>R</b>	<b>BU</b>

<b>BR=</b> Brass	<b>TN=</b> Tin plated	<b>NO=</b> Screw Not Mounted	<b>M4=</b> Screw size	<b>R=</b> ROHS Conform	<b>BU=</b> Bulk Ware
	<b>NI=</b> Nickel plated	<b>YE=</b> Screw Fixed on Terminal		<b>N=</b> NON ROHS	

**PCB Power Terminal**

Part No.: **A25047**

Customer:

DRW:	Jason	CHKD	Jules	MATL:	Wu	DATE	17.11.2017
APPD:	Join			FINISH	Shieh	Sheet	1 from 1