

DATA SHEET

Passive SMD Magnetic Buzzer

Serie: Y10029

**Passive SMD Magnetic
Buzzer**

Serie No.: **Y10029**

Customer:

DRW:	Jason	CHKD	Wilson	MATL:	Wilson	TOLERANCE	Mason	DATE	01.11.2017
APPD:	Schumi			FINISH	Jamy		Sheet No.		1 from 5

EDCON-COMPONENTS

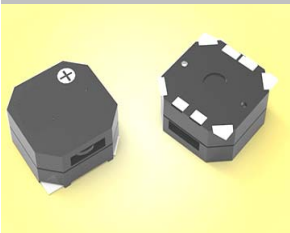

Drawing

UNIT: mm TOL:±0.3

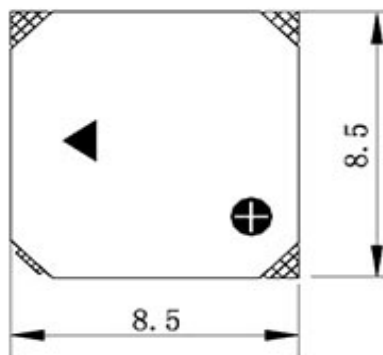

TOP VIEW

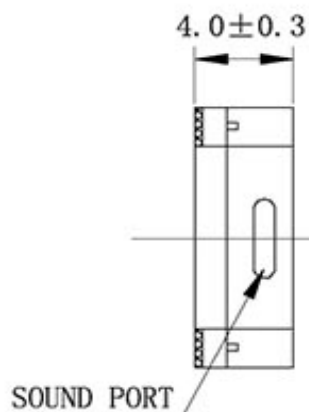

SIDE VIEW

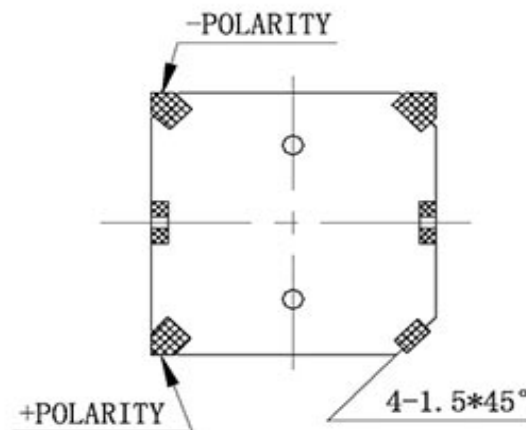

BOTTOM VIEW

Passive SMD Magnetic Buzzer

Part No.: **Y10029**

Customer:

DRW:	Jason	CHKD	Wilson	MATL:	Wilson	TOLERANCE	Mason	DATE	01.11.2017
APPD:	Schumi			FINISH	Jamy		Sheet No.	2 from 5	

EDCON-COMPONENTS



Technical Features

Rated Voltage:	5,0	(Vp-p)
Operating Voltage:	4,5~6,5	(Vp-p)
Oscillation Frequency:	2731	Hz
Current Consumption (mA/max) rated V.	90	mA
Sound Pressure Level :@ 10cm rated V.	86	dB
Coil Resistance:	31 ±4	Ω
Audible distance at rated Vol.	10	Meter
Operating Temperature:	-20~ +85	°C
Storage Temperature:	-30~ +95	°C
Dimensions:L x W x H	8,5x8,5x4,0	mm
Weight:	0,4	g
Material:		
Housing:	LCP Plastic Resin	Black
Termination:	SMD	
Packing Unit:	1000	PCS

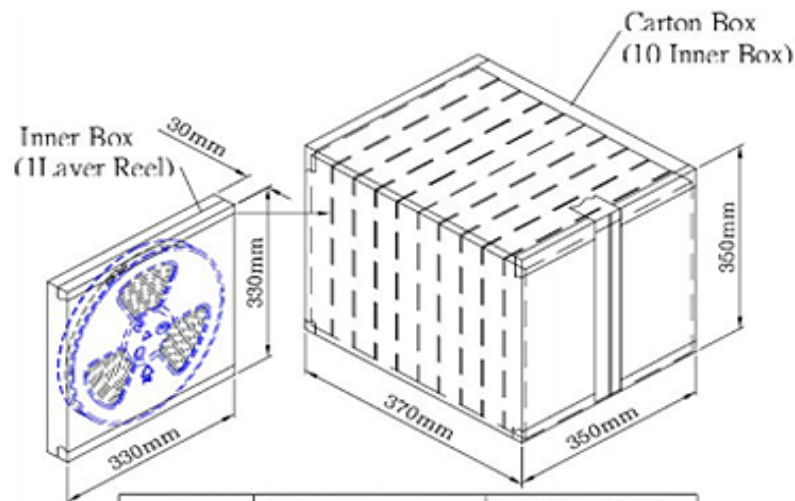
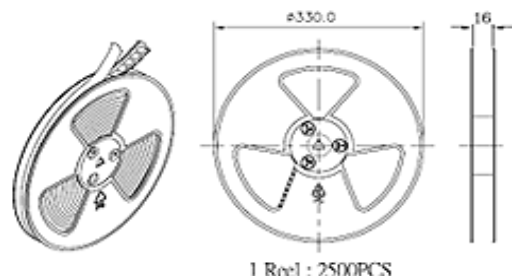
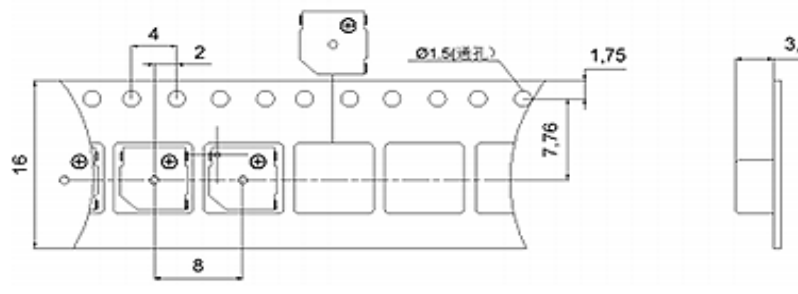

Inner Box	330mmx330mmx30mm	1x2500PCS=2500PCS
Carton Box	350mmx350mmx370mm	10x2500PCS=25.000PCS

Passive SMD Magnetic Buzzer

Part No.: **Y10029**

Customer:

DRW:	Jason	CHKD	Wilson	MATL:	Wilson	TOLERANCE	Mason	DATE	01.11.2017
APPD:	Schumi			FINISH	Jamy		Sheet No.		3 from 5

EDCON-COMPONENTS

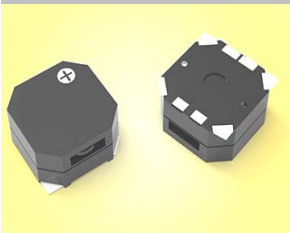

Ordering Informations

Serie	Special function	Special function	Special function	Special function	ROHS	Packing Code				
-------	------------------	------------------	------------------	------------------	------	--------------	--	--	--	--

Y10029	-	N	N	N	N	R	TR			
---------------	---	----------	----------	----------	----------	----------	-----------	--	--	--

0= no special function	0= no special function	0= no special function	0= no special function	R= ROHS Conform	BU= Bulk Ware
				N= NON ROHS Conform	TU= TUBE Packing
					TY= TRAY Packing
					TR= TAPE REEL Packing
					IV= Individual Packing

Passive SMD Magnetic Buzzer

Part No.: **Y10029**

DRW:	Jason	CHKD	Wilson	MATL:	Wilson	TOLERANCE	Mason	DATE	01.11.2017
APPD:	Schumi			FINISH	Jamy		Sheet No.		4 from 5

Customer:

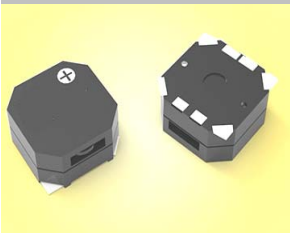

Soldering Profile Curve

Classification Reflow Profile (JEDEC J-STD-020C)

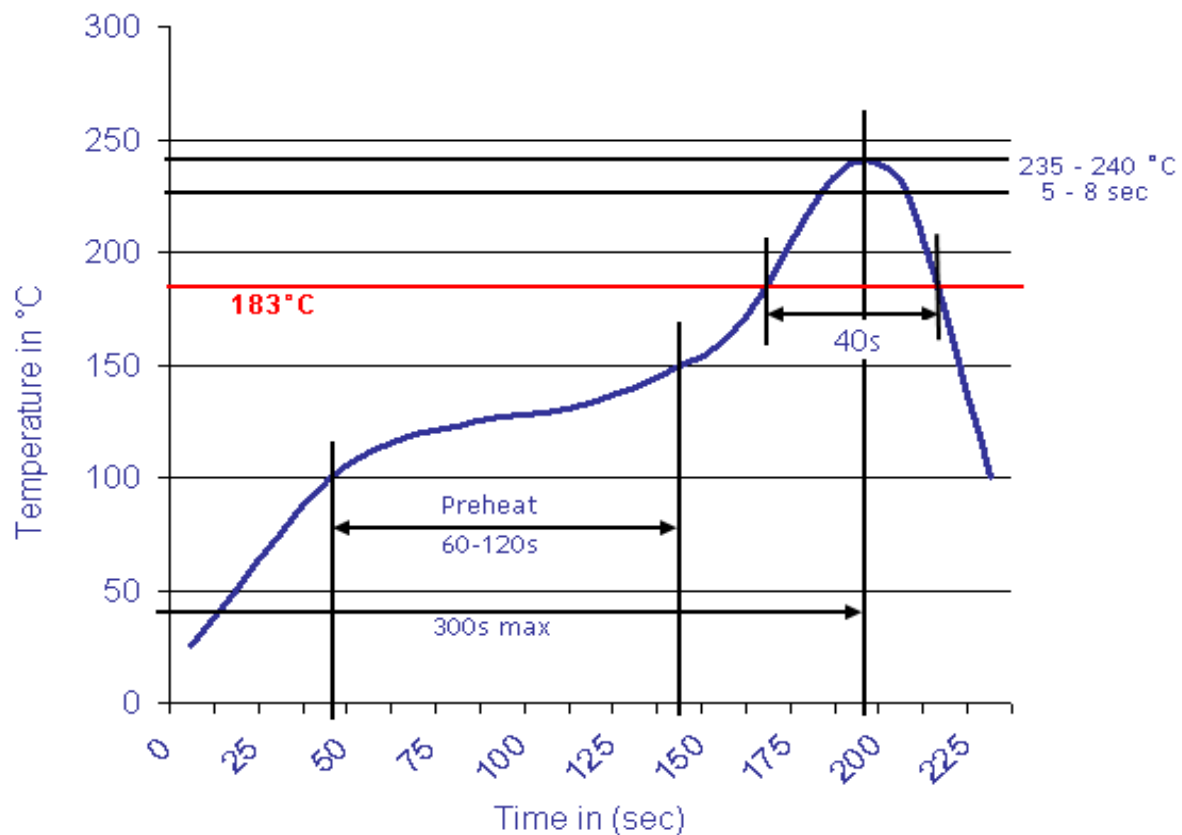

Passive SMD Magnetic Buzzer

Part No.: **Y10029**

Customer:

DRW:	Jason	CHKD	Wilson	MATL:	Wilson	TOLERANCE	Mason	DATE	01.11.2017
APPD:	Schumi			FINISH	Jamy		Sheet No.	5 from 5	