



DATA SHEET

SMD Piezo Buzzer

Serie: Y12013

SMD Piezo Buzzer

Serie No.: **Y12013**

Customer:

DRW:	Jason	CHKD	Wilson	MATL:	Wilson	TOLERANCE	Mason	DATE	01.11.2017
APPD:	Schumi			FINISH	Jamy		Sheet No.		1 from 5

EDCON-COMPONENTS



Drawing

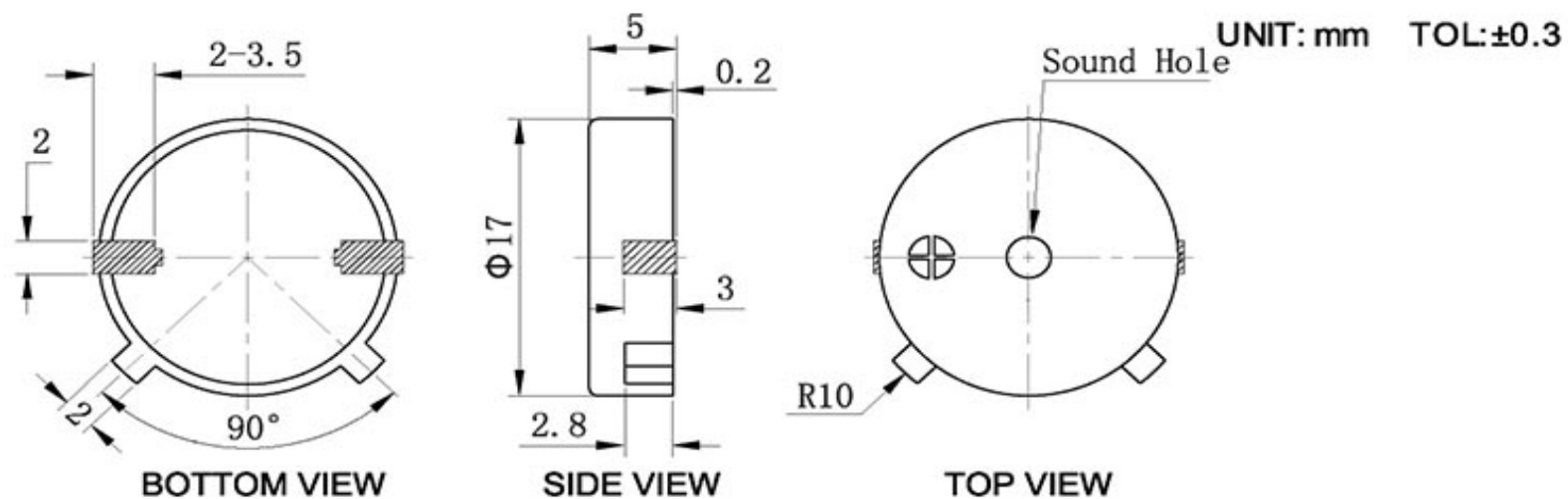

SMD Piezo Buzzer

Part No.: Y12013

Customer:

DRW:	Jason	CHKD	Wilson	MATL:	Wilson	TOLERANCE	Mason	DATE	01.11.2017
APPD:	Schumi			FINISH	Jamy		Sheet No.	2 from 5	

EDCON-COMPONENTS

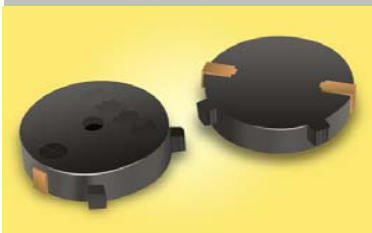

Technical Features

Operating Voltage:(Vp-p)		V
Rated Voltage:(Vp-p)		V
Current Consumption at (5Vp-p)		3 mA
at Square Wave /	4,0	KHz
Sound Pressure Level :@ 10cm (5Vp-p)	>82	dB
at Sine Wave /	4,0	KHz
Electrostatic Capacity at 1KHZ/1V	15000±30	pf
Audible distance at rated Vol.	1	Meter
Operating Temperature:	-40~ +85	°C
Storage Temperature:	-30~ +85	°C
Dimensions:L x W x H	17,0x5,0	mm
Weight:	1,3	g
Material:		
Housing:	LCP Plastic Resin	Black
Termination:		SMD
Packing Unit:		1000 PCS

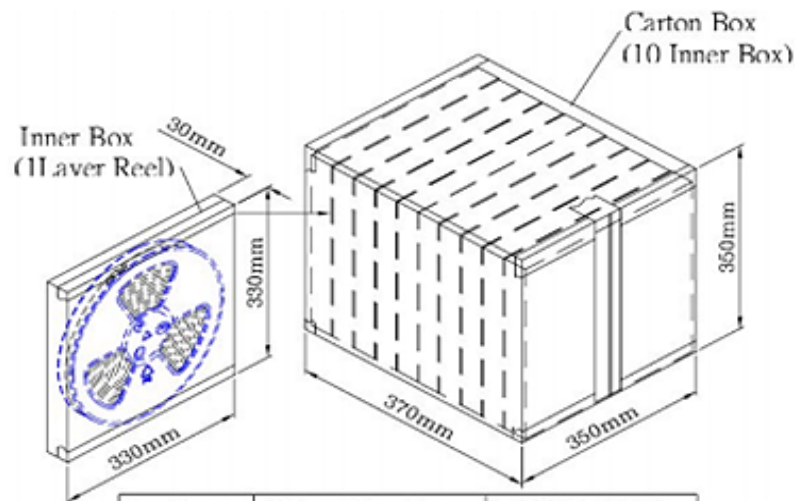
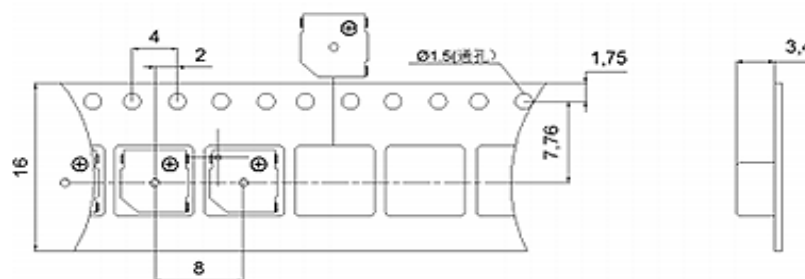

Inner Box	330mmx330mmx30mm	1x2500PCS=2500PCS
Carton Box	350mmx350mmx370mm	10x2500PCS=25.000PCS

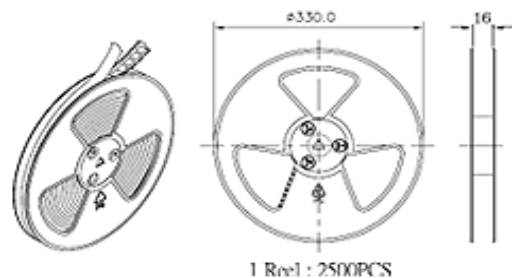

SMD Piezo Buzzer	
Part No.:	Y12013

DRW:	Jason	CHKD	Wilson	MATL:	Wilson	TOLERANCE	Mason	DATE	01.11.2017	Customer:
APPD:	Schumi			FINISH	Jamy		Sheet No.	3 from 5		

EDCON-COMPONENTS

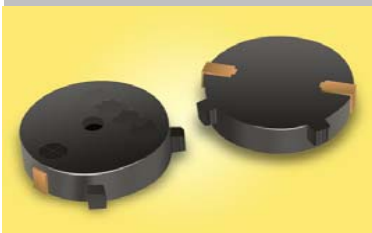

Ordering Informations

Serie	Special function	Special function	Special function	Special function	ROHS	Packing Code				
-------	------------------	------------------	------------------	------------------	------	--------------	--	--	--	--

Y12013	-	N	N	N	N	R	TR			
--------	---	---	---	---	---	---	----	--	--	--

0= no special function	0= no special function	0= no special function	0= no special function	R= ROHS Conform	BU= Bulk Ware
				N= NON ROHS Conform	TU= TUBE Packing
					TY= TRAY Packing
					TR= TAPE REEL Packing
					IV= Individual Packing

SMD Piezo Buzzer	
Part No.:	Y12013
Customer:	

DRW:	Jason	CHKD	Wilson	MATL:	Wilson	TOLERANCE	Mason	DATE	01.11.2017
APPD:	Schumi			FINISH	Jamy		Sheet No.		4 from 5

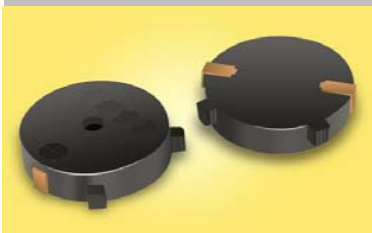

Soldering Profile Curve

Classification Reflow Profile (JEDEC J-STD-020C)

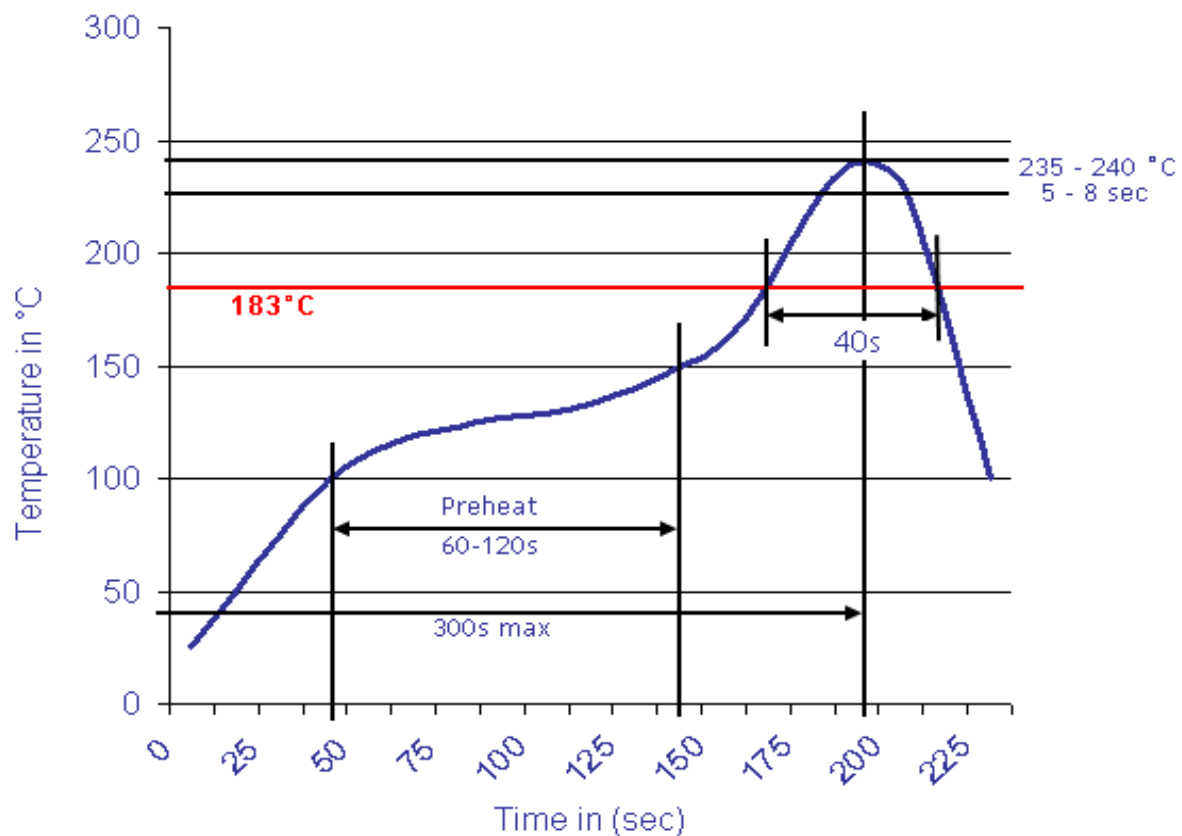

SMD Piezo Buzzer	
Part No.:	Y12013
Customer:	

DRW:	Jason	CHKD	Wilson	MATL:	Wilson	TOLERANCE	Mason	DATE	01.11.2017
APPD:	Schumi			FINISH	Jamy		Sheet No.	5 from 5	