



DATA SHEET

SMD Piezo Buzzer

Serie: Y12012

SMD Piezo Buzzer

Serie No.: **Y12012**

Customer:

DRW:	Jason	CHKD	Wilson	MATL:	Wilson	TOLERANCE	Mason	DATE	01.11.2017
APPD:	Schumi			FINISH	Jamy		Sheet No.		1 from 5

EDCON-COMPONENTS



Drawing

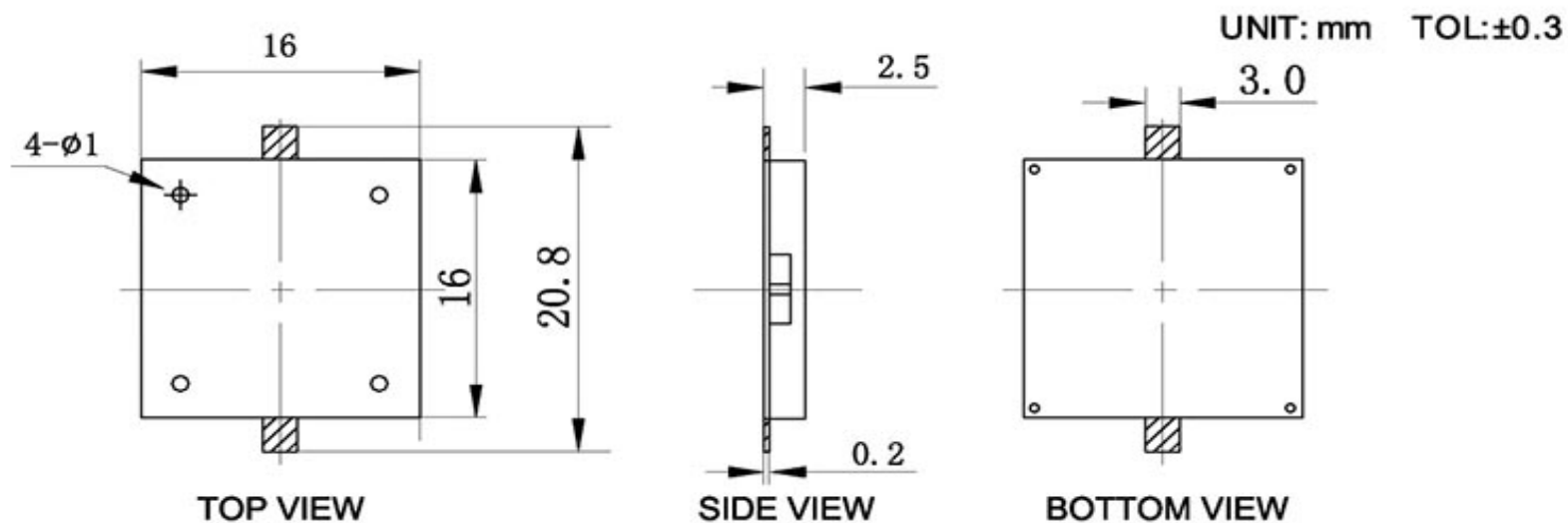

SMD Piezo Buzzer

Part No.: **Y12012**

Customer:

DRW:	Jason	CHKD	Wilson	MATL:	Wilson	TOLERANCE	Mason	DATE	01.11.2017
APPD:	Schumi			FINISH	Jamy		Sheet No.	2 from 5	

EDCON-COMPONENTS



Technical Features

Operating Voltage:(Vp-p)	25,0	V
Current Consumption at (5Vp-p)	2	mA
at Square Wave /	4,1	KHZ
Sound Pressure Level :@ 10cm (5Vp-p)	>75	dB
at Square Wave /	4,1	KHZ
Electrostatic Capacity at 1KHZ/1V	15000±30	pf
Audible distance at rated Vol.	3	Meter
Operating Temperature:	-40~ +85	°C
Storage Temperature:	-30~ +85	°C
Dimensions:L x W x H	16,0x16,0x2,5	mm
Weight:	0,7	g
Material:		
Housing:	LCP Plastic Resin	Black
Termination:	SMD	
Packing Unit:	2000	PCS

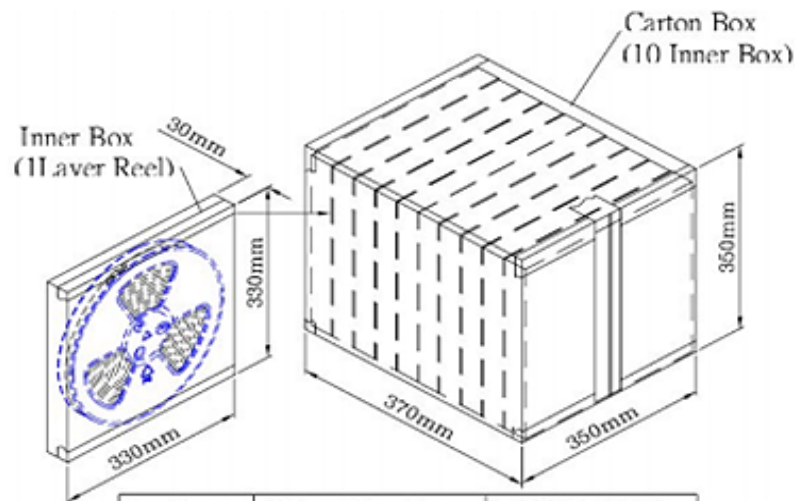
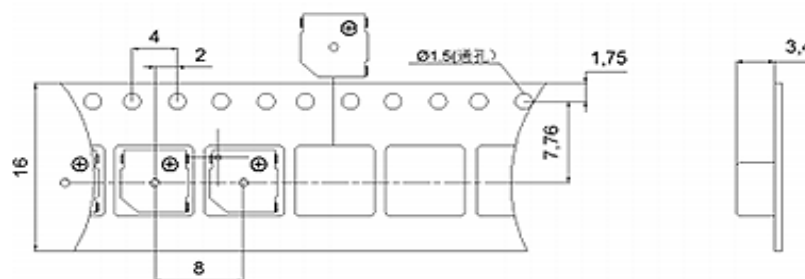

Inner Box	330mmx330mmx30mm	1x2500PCS=2500PCS
Carton Box	350mmx350mmx370mm	10x2500PCS=25.000PCS

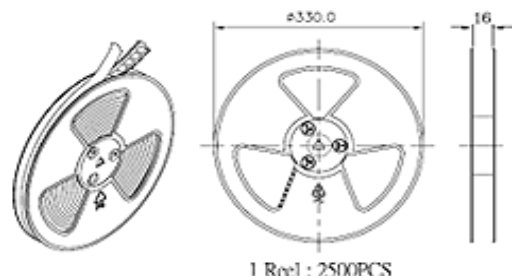

SMD Piezo Buzzer	
Part No.:	Y12012
Customer:	

DRW:	Jason	CHKD	Wilson	MATL:	Wilson	TOLERANCE	Mason	DATE	01.11.2017
APPD:	Schumi			FINISH	Jamy		Sheet No.		3 from 5

EDCON-COMPONENTS



Ordering Informations

Serie	Special function	Special function	Special function	Special function	ROHS	Packing Code				
-------	------------------	------------------	------------------	------------------	------	--------------	--	--	--	--

Y12012	-	N	N	N	N	R	TR			
--------	---	---	---	---	---	---	----	--	--	--

0= no special function	0= no special function	0= no special function	0= no special function	R= ROHS Conform	BU= Bulk Ware
				N= NON ROHS Conform	TU= TUBE Packing
					TY= TRAY Packing
					TR= TAPE REEL Packing
					IV= Individual Packing

SMD Piezo Buzzer	
Part No.:	Y12012
Customer:	

DRW:	Jason	CHKD	Wilson	MATL:	Wilson	TOLERANCE	Mason	DATE	01.11.2017
APPD:	Schumi			FINISH	Jamy			Sheet No.	4 from 5

EDCON-COMPONENTS

Datei Bearbeiten Ansicht Chronik Lesezeichen Extras Hilfe

Hoyato Electronics(...) ShenZhen Antenk El... Products- LED ... FB-WIFI-104-3... Störmeldemodu... Urlaubsanspruc... Gesetzliche Kündigung... Opel Vectra 1...

www.keliking.com/KL J-1625-SMD-Piezo-Buzzer-pd6394765.html

Meistbesucht Erste Schritte Deutsch - edcon-com... WWW leo.org Währungsrechner | O... Google Übersetzer google translate - Go... Google Maps CEE Stecker w

Product Description

Product Introduction

Operating voltage
Current Consumption
Sound Pressure Level
Electrostatic Capacity
Operating Temperature(°C)
Storage Temperature(°C)
Environment Compulsory Standard
PS: Vp-p=1/2duty, square wave
Application Range
Audible distance at rated vol.
Application

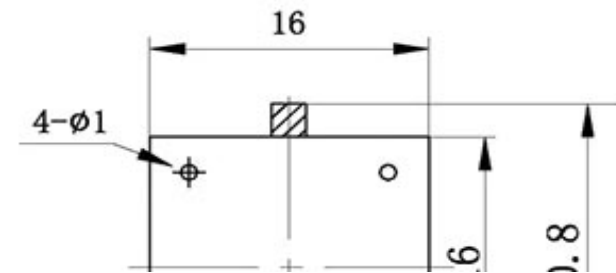

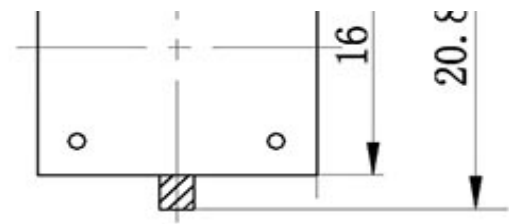

TOP VIEW



Package	Our Company
max20vp-p	
Max 2mA at 5Vp-p/Square Wave/4.1KHz	
Min 75dB at 10cm/ 5Vp-p/Square Wave/4.1KHz	
15000±30%pF at 1 KHz/1V	
-20~ +85	
-30 ~ +85	
ROHS	
3m	
Ear thermometer, electronic manometer, electronic glucometer, electronic oximeter, home appliances and more	

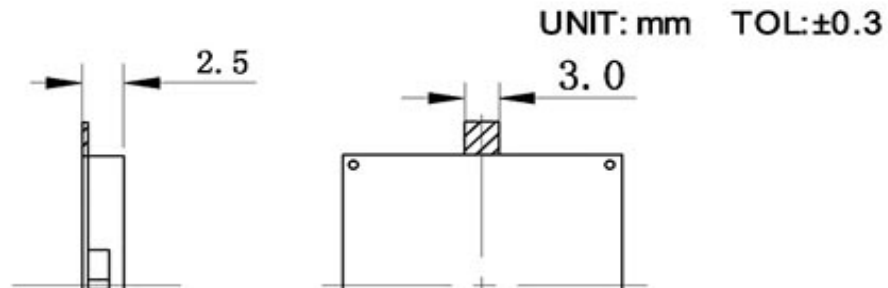

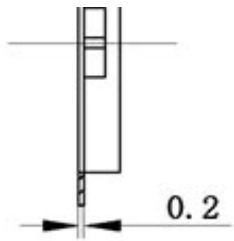

SIDE VIEW

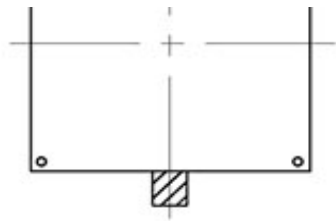

BOTTOM VIEW

