

EDCON-COMPONENTS

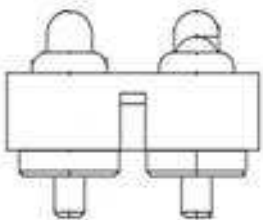

Technical Discription

1 Material:

Material Body:	C2700
Gold Plated:	16-20µm
Nickel:	60-120µm
Material Needle:	C3604
Gold Plated:	4-8µm
Nickel:	60-120µm
Spring:	SUS304
Body:	PA46

2 Mechanical Properties

Pitch:	3,00mm
Working height:	7,8~8,1mm
Elastic:	100 ±20gr

Lifetime:more than 10000 times

3 Electrical Performance:

4 Isolation Resistance:	500M Ohm min.
Withstanding Voltage:	500VAC/DC
Max.Rated Voltage:	36VDC dynamic range of work with impedance less than

Contact Resistance: <30m Ohm

Rated current: 2,5A

5 Packing Specification:

6 Max.Soldering Temperature:	260°C
Operating Temperature:	-.40°C to +85°C

Drawing

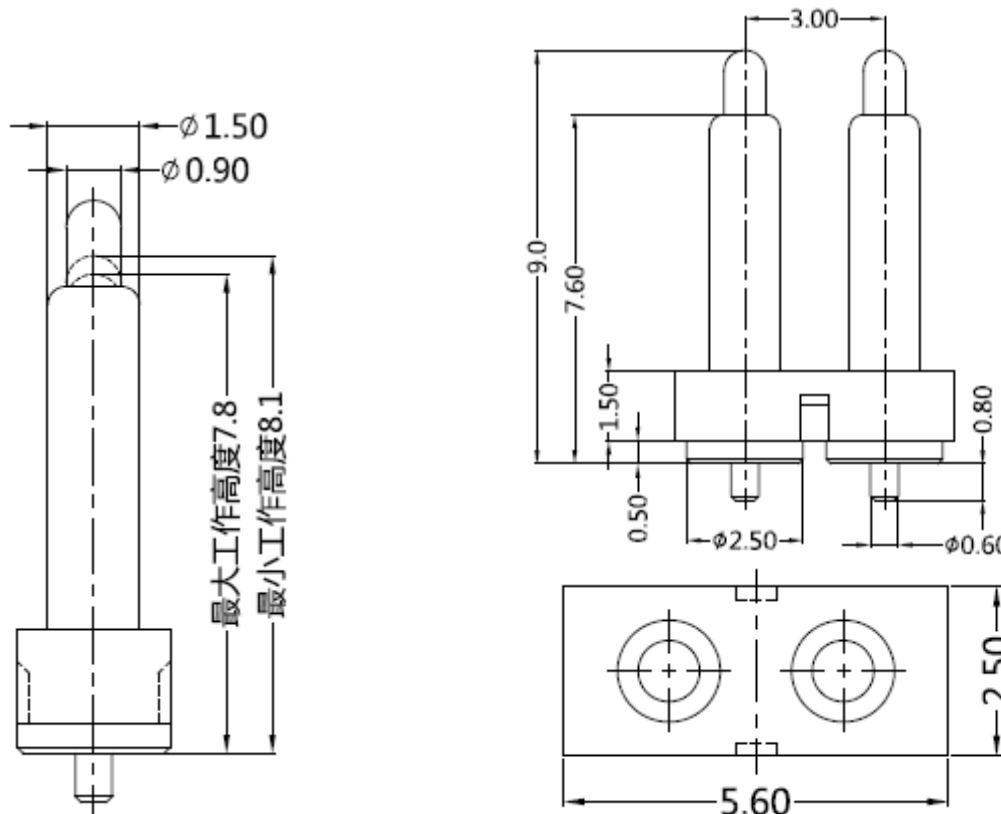

THT 2 POGO PIN with Plastic

Part No.: TA23C2060

Customer:

DRW:	Jason	CHKD	Wilson	MATL:	Wilson	TOLERANCE	Mason	DATE	06.12.2017
APPD:	Schumi			FINISH	Jamy		Sheet No.		1 from 3

EDCON-COMPONENTS



PCB Layout (mm)

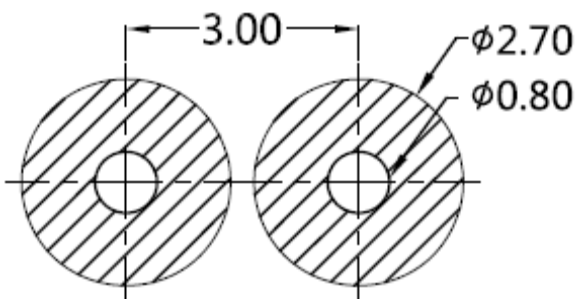

Ordering Informations

Serie	Number of Position	Material Body	Material Needle	Contact Plat. Body	Contact Plat. Needle	Spezial Function	ROHS	Packing		
TA23C2060	02	A	A	G0	G0	N	R	BU		

02= Position	A= Material C3604	A= Material C3604	G0= Gold Flash <16-20µinch	G0= Gold Flash 4-8µinch	N= No function	R= ROHS Conform	BU= Bulk-Ware Standard
	B= Material C2700	B= Material C2700					
			NO= Nickel 60-120µinch	NO= Nickel 60-120µinch			TU= Tube Packing

THT 2 POGO PIN with Plastic
Part No.: TA23C2060

DRW:	Jason	CHKD	Wilson	MATL:	Wilson	TOLERANCE	Mason	DATE	06.12.2017	Customer:
APPD:	Schumi			FINISH	Jamy		Sheet No.	2 from 3		



Soldering Profile Curve

Classification Reflow Profile (JEDEC J-STD-020C)



THT 2 POGO PIN with Plastic	
Part No.:	TA23C2060
Customer:	

DRW:	Jason	CHKD	Wilson	MATL:	Wilson	TOLERANCE	Mason	DATE	06.12.2017
APPD:	Schumi			FINISH	Jamy		Sheet No.	3 from 3	