

EDCON-COMPONENTS

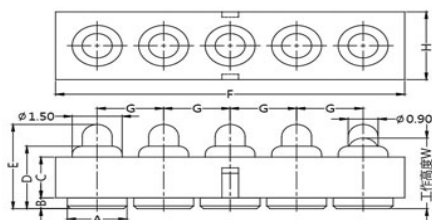

Technical Discription

Drawing

1 Material:

Material Body:	C2700
Gold Plated:	16-20µm
Nickel:	60-120µm
Material Needle:	C3604
Gold Plated:	4-8µm
Nickel:	60-120µm
Spring:	SUS304
Body:	PA46

2 Mechanical Properties

Pitch:	2,54mm
Working height:	2,8~3,1mm
Elastic:	85±15gr

Lifetime: more than 10000 times

3 Electrical Performance:

4 Isolation Resistance:	500M Ohm min.
Withstanding Voltage:	500VAC/DC
Max. Rated Voltage:	36VDC dynamic range of work with impedance less than
Contact Resistance:	<30m Ohm
Rated current:	2,5A
5 Packing Specification:	EIA 481
6 Max. Soldering Temperature:	260°C
Operating Temperature:	-.40°C to +85°C

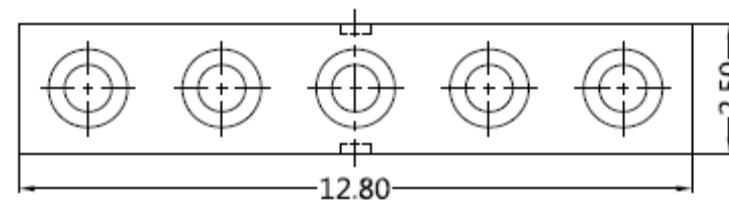
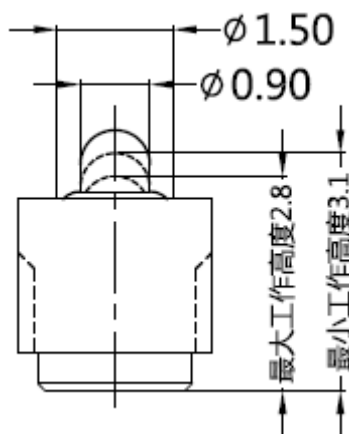
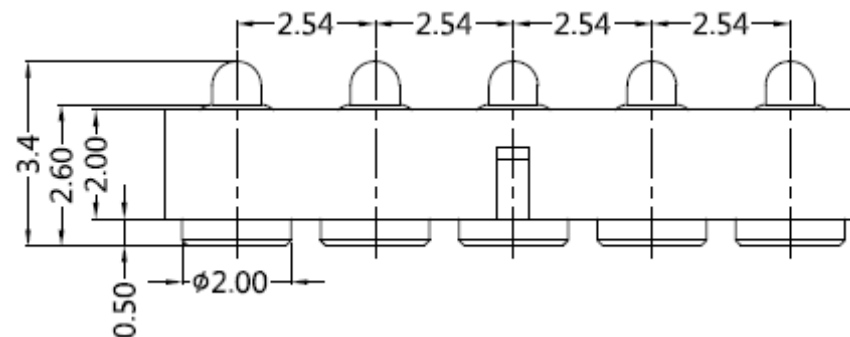

5 POGO PIN with Plastic

Part No.: **TA23B6005**

Customer:

DRW:	Jason	CHKD	Wilson	MATL:	Wilson	TOLERANCE	Mason	DATE	05.12.2017
APPD:	Schumi			FINISH	Jamy	Sheet No.			1 from 3

EDCON-COMPONENTS

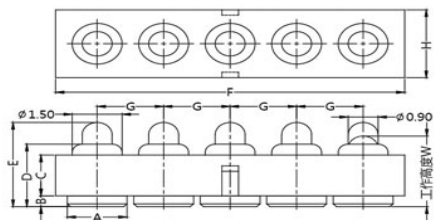

PCB Layout (mm)

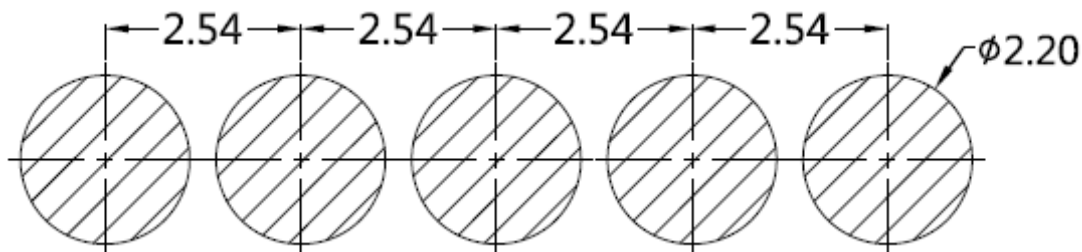

Ordering Informations

Serie	Number of Position	Material Body	Material Needle	Contact Plat. Body	Contact Plat. Needle	Spezial Function	ROHS	Packing		
TA23B6005	05	A	A	G0	G0	N	R	BU		

05= Position	A= Material C3604	A= Material C3604	G0= Gold Flash <math><16-20\mu\text{inch}</math>	G0= Gold Flash 4-8μinch	N= No function	R= ROHS Conform	BU= Bulk-Ware Standard
	B= Material C2700	B= Material C2700					
			N0= Nickel 60-120μinch	N0= Nickel 60-120μinch			TR= Tape Reel

5 POGO PIN with Plastic
Part No.: TA23B6005

DRW:	Jason	CHKD	Wilson	MATL:	Wilson	TOLERANCE	Mason	DATE	05.12.2017	Customer:
APPD:	Schumi			FINISH	Jamy		Sheet No.	2 from 3		

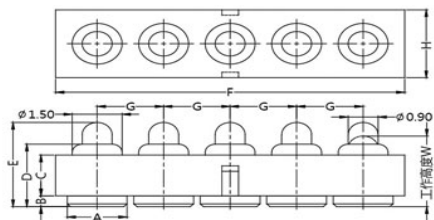

Soldering Profile Curve

Classification Reflow Profile (JEDEC J-STD-020C)

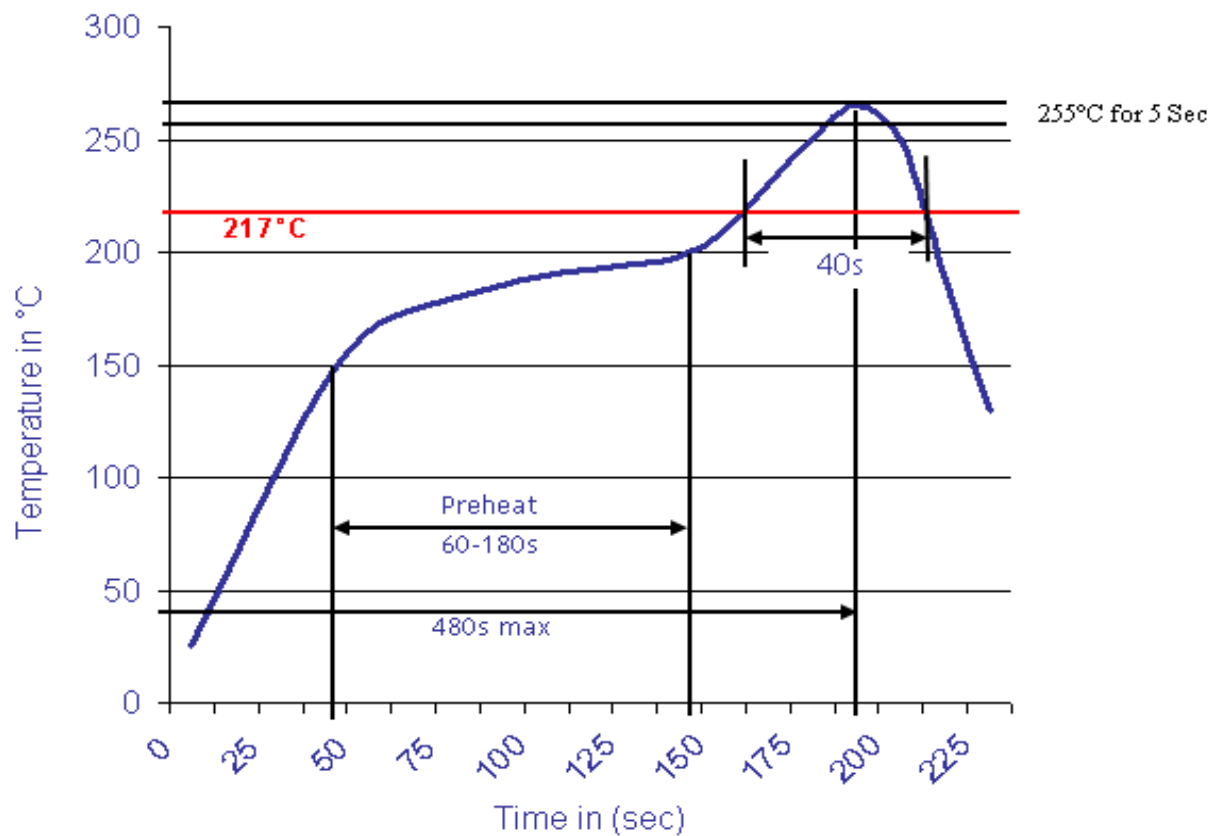

5 POGO PIN with Plastic	
Part No.:	TA23B6005
Customer:	

DRW:	Jason	CHKD	Wilson	MATL:	Wilson	TOLERANCE	Mason	DATE	05.12.2017
APPD:	Schumi			FINISH	Jamy		Sheet No.	3 from 3	