

# EDCON-COMPONENTS

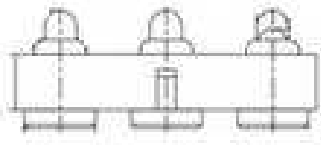

## Technical Discription

## Drawing

### 1 Material:

Material Body:	C2700
Gold Plated:	16-20µm
Nickel:	60-120µm
Material Needle:	C3604
Gold Plated:	4-8µm
Nickel:	60-120µm
Spring:	SUS304
Body:	PA46

### 2 Mechanical Properties

Pitch:	2,54mm
Working height:	3,0~3,3mm
Elastic:	85± 15g

Lifetime: more than 10000 times

### 3 Electrical Performance:

4 Isolation Resistance:	500M Ohm min.
Withstanding Voltage:	500VAC/DC
Max. Rated Voltage:	36VDC dynamic range of work with impedance less than

Contact Resistance: <30m Ohm

Rated current: 2,5A

5 Packing Specification: EIA 481

6 Max. Soldering Temperature: 260°C

Operating Temperature: -40°C to +85°C

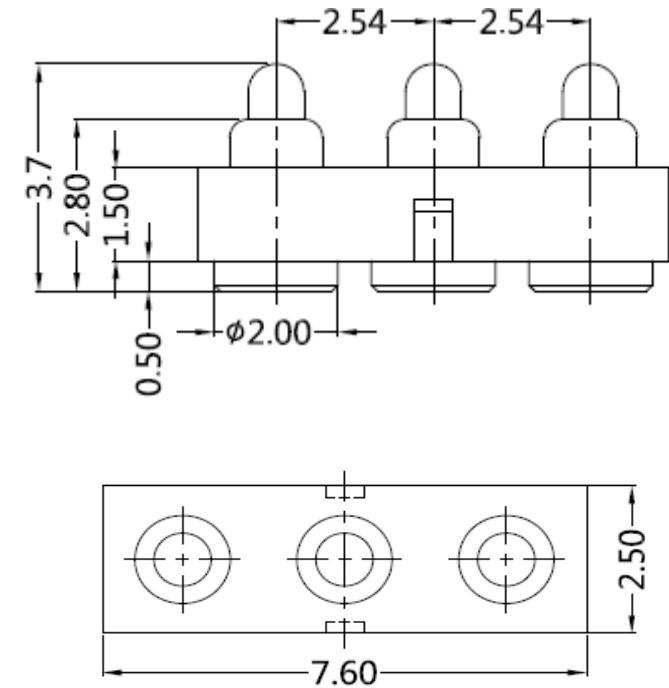
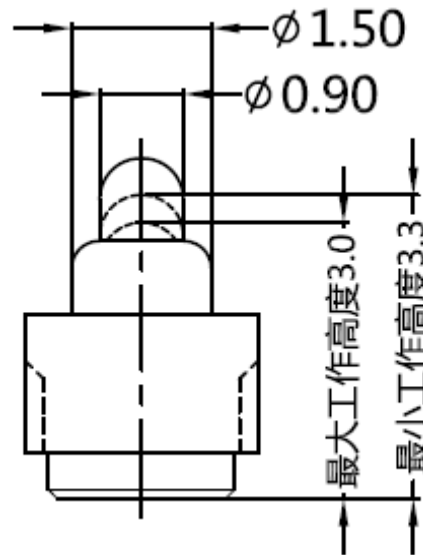

### 3 POGO PIN with Plastic

Part No.: TA23B4006

Customer:

DRW:	Jason	CHKD	Wilson	MATL:	Wilson	TOLERANCE	Mason	DATE	05.12.2017
APPD:	Schumi			FINISH	Jamy		Sheet No.		1 from 3

# EDCON-COMPONENTS

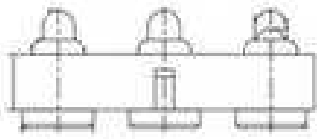

## PCB Layout ( mm)

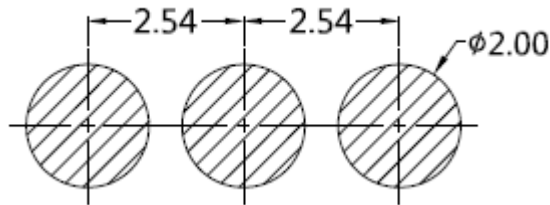

## Ordering Informations

Serie	Number of Position	Material Body	Material Needle	Contact Plat. Body	Contact Plat. Needle	Spezial Function	ROHS	Packing		
TA23B4006	03	A	A	G0	G0	N	R	BU		

03= Position	A= Material C3604	A= Material C3604	G0= Gold Flash <16-20µinch	G0= Gold Flash 4-8µinch	N= No function	R= ROHS Conform	BU= Bulk-Ware Standard
	B= Material C2700	B= Material C2700					
			NO= Nickel 60-120µinch	NO= Nickel 60-120µinch			TR= Tape Reel

**3 POGO PIN with Plastic**  
Part No.: **TA23B4006**

DRW:	Jason	CHKD	Wilson	MATL:	Wilson	TOLERANCE	Mason	DATE	05.12.2017	Customer:
APPD:	Schumi			FINISH	Jamy		Sheet No.	2 from 3		

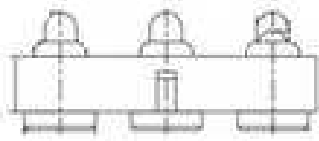

Soldering Profile Curve

Classification Reflow Profile (JEDEC J-STD-020C)

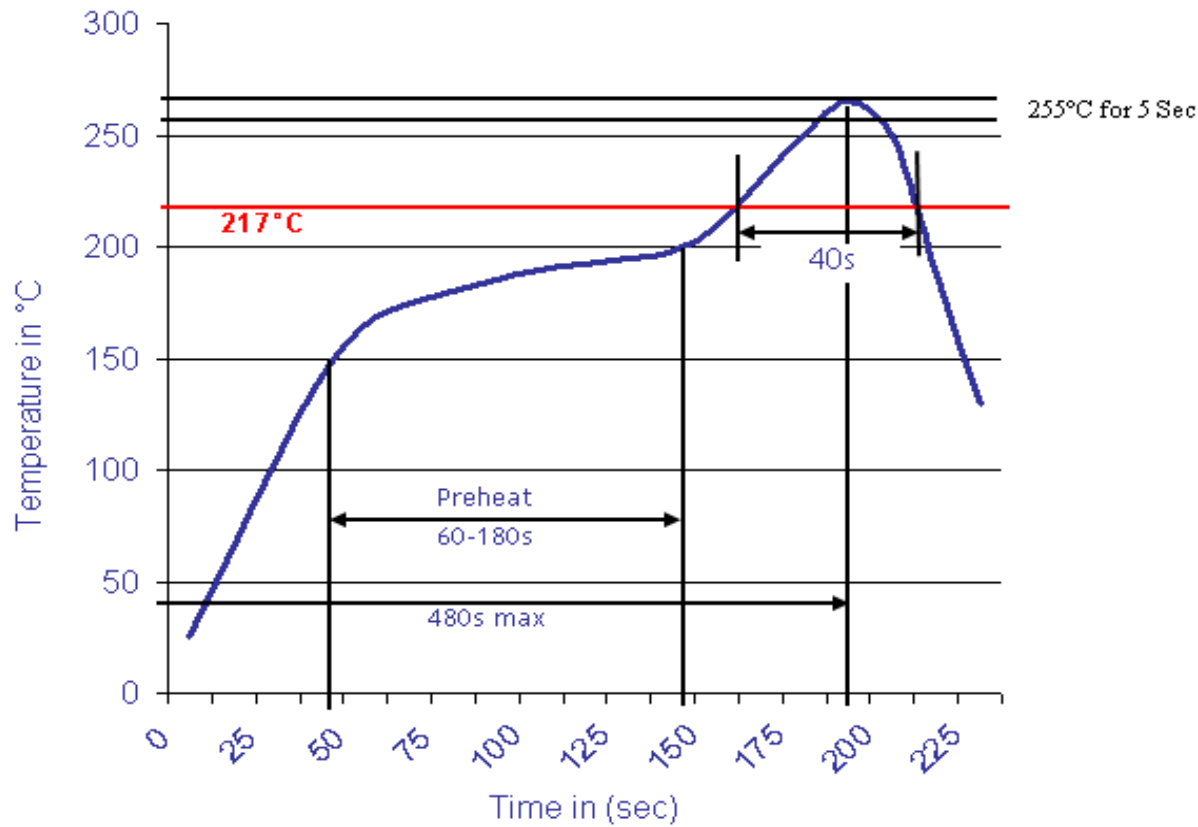

<b>3 POGO PIN with Plastic</b>
Part No.: <b>TA23B4006</b>
Customer:

DRW:	Jason	CHKD	Wilson	MATL:	Wilson	TOLERANCE	Mason	DATE	05.12.2017
APPD:	Schumi			FINISH	Jamy		Sheet No.	3 from 3	