

EDCON-COMPONENTS



Technical Discription

1 Material:

Material Body:	C2700
Gold Plated:	16-20µm
Nickel:	60-120µm
Material Needle:	C3604
Gold Plated:	4-8µm
Nickel:	60-120µm
Spring:	SUS304
Body:	PA46

2 Mechanical Properties

Pitch:	3,0mm
Working height:	6,2~6,5mm
Elastic:	100 ± 20g

Lifetime: more than 10000 times

3 Electrical Performance:

4 Isolation Resistance:	500M Ohm min.
Withstanding Voltage:	500VAC/DC
Max. Rated Voltage:	36VDC dynamic range of work with impedance less than
Contact Resistance:	<30m Ohm
Rated current:	2,5A
5 Packing Specification:	EIA 481
6 Max. Soldering Temperature:	260°C
Operating Temperature:	-.40°C to +85°C

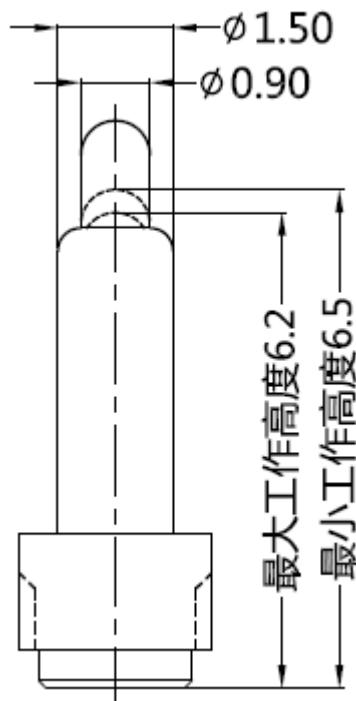

Drawing

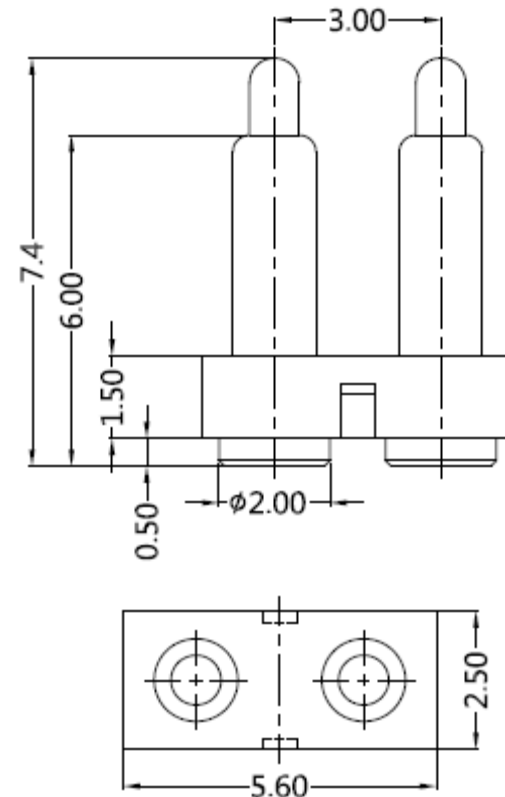

2 POGO PIN with Plastic

Part No.: TA23B3052

Customer:

Tolerance			
0.	0.0	0.00	0.000
± -	± 0,30	± 0,15	± -
TOLERANCE	Mason	DATE	22.11.2017
Sheet No.			1 from 3

DRW:	Jason	CHKD	Wilson	MATL:	Wilson
APPD:	Schumi			FINISH	Jamy

EDCON-COMPONENTS



PCB Layout (mm)

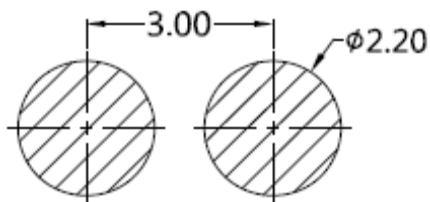

Ordering Informations

Serie	Number of Position	Material Body	Material Needle	Contact Plat. Body	Contact Plat. Needle	Spezial Function	ROHS	Packing		
TA23B3052	02	A	A	G0	G0	N	R	BU		

02= Single Pole	A= Material C3604	A= Material C3604	G0= Gold Flash <16-20µinch	G0= Gold Flash 4-8µinch	N= No function	R= ROHS Conform	BU= Bulk-Ware Standard
	B= Material C2700	B= Material C2700					
			NO= Nickel 60-120µinch	NO= Nickel 60-120µinch			TR= Tape Reel

2 POGO PIN with Plastic

Part No.: TA23B3052

DRW:	Jason	CHKD	Wilson	MATL:	Wilson	TOLERANCE	Mason	DATE	22.11.2017	Customer:
APPD:	Schumi			FINISH	Jamy		Sheet No.	2 from 3		



Soldering Profile Curve

Classification Reflow Profile (JEDEC J-STD-020C)



2 POGO PIN with Plastic
Part No.: TA23B3052
Customer:

DRW:	Jason	CHKD	Wilson	MATL:	Wilson	TOLERANCE	Mason	DATE	22.11.2017
APPD:	Schumi			FINISH	Jamy		Sheet No.	3 from 3	