

# EDCON-COMPONENTS



## Specifications

|                        |                              |
|------------------------|------------------------------|
| Switch Rating:         |                              |
| Contact Configuration: |                              |
| Operating Type:        |                              |
| IP-Degree:             | IP65 / IP67 ( Made by Order) |
| Crust Material:        | Stainless Steel              |
| Terminal Type:         | Solder Lug (2,8x0,5mm)       |
| Switching:             |                              |
| Contact Resistance:    | ≤ 50mΩ                       |
| Insulation Resistance: | ≥ 1000MΩ                     |
| Dielectric Strength:   | 2000VAC                      |
| Operating Temperature: | . -20°C ~ +55°C              |
| Mechanical Life:       |                              |
| Electrical Life:       |                              |
| Panel Thickness:       | 1 ~ 10mm                     |
| Torque:                | 5 ~ 14Nm                     |
| Operating Pressure:    |                              |
| Operating Distance:    |                              |

## Material

|                |   |   |   |   |   |   |   |   |
|----------------|---|---|---|---|---|---|---|---|
| Contact:       | Silver Alloy  |   |   |   |   |   |   |   |
| Button:        | Stainless Steel   |   |   |   |   |   |   |   |
| Body:          | Stainless Steel   |   |   |   |   |   |   |   |
| Base:          | PBT   |   |   |   |   |   |   |   |
| ROHS:          | Made to Order-Code  |   |   |   |   |   |   |   |
| Type:          | Illuminated (LED)   |   |   |   |   |   |   |   |
| Color:         | <table border="0" style="display: inline-table; vertical-align: middle;"> <tr> <td style="background-color: red; color: white; padding: 2px;">R</td> <td style="background-color: yellow; color: black; padding: 2px;">Y</td> <td style="background-color: orange; color: black; padding: 2px;">O</td> <td style="padding: 0 10px;"> </td> <td style="background-color: green; color: white; padding: 2px;">G</td> <td style="background-color: cyan; color: white; padding: 2px;">B</td> <td style="background-color: grey; color: white; padding: 2px;">W</td> </tr> </table> | R | Y | O |   | G | B | W |
| R              | Y   | O |   | G | B | W |   |   |
| Rated Voltage: | AC/DC 1,7V      AC/DC 2,8V  |   |   |   |   |   |   |   |
| Rated Current: | 20mA  |   |   |   |   |   |   |   |
| Lifetime:      | 40000Hrs  |   |   |   |   |   |   |   |

## Drawing

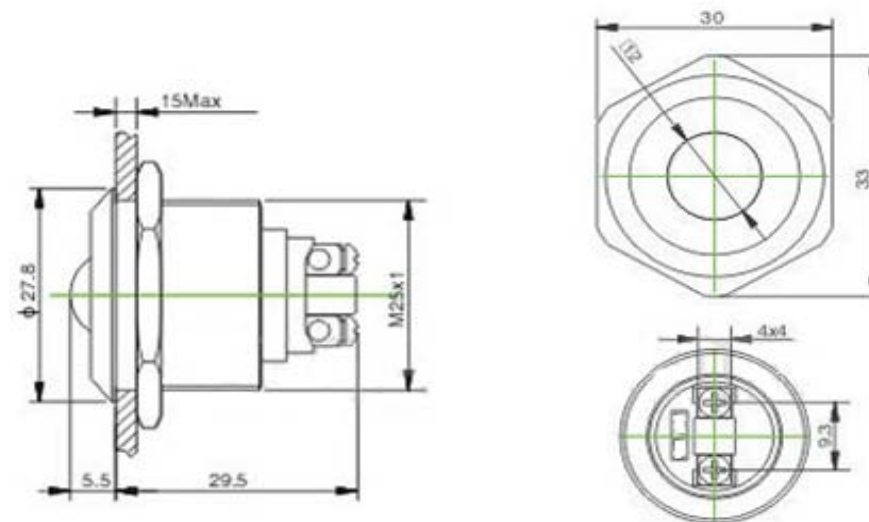

Current Limiting Resistance Configuration Table

| Operating Voltage (U)      | 6V         | 12V        | 24V         | 36V         |
|----------------------------|------------|------------|-------------|-------------|
| <b>R</b> <b>Y</b> <b>O</b> | 210Ω, 1/4W | 510Ω, 1/4W | 1,2KΩ, 1/4W | 2,2KΩ, 1/4W |
| <b>G</b> <b>B</b> <b>W</b> | 160Ω, 1/4W | 470Ω, 1/4W | 1,2KΩ, 1/4W | 2,2KΩ, 1/4W |

|         |                       |
|---------|-----------------------|
| Formula |                       |
| R=      | $\frac{U - U_e}{I_e}$ |

**28MM Anti-Vandal-Pilot Lamp**

Part No.: **Q35079**

|       |        |      |        |        |        |           |           |          |            |           |
|-------|--------|------|--------|--------|--------|-----------|-----------|----------|------------|-----------|
| DRW:  | Jason  | CHKD | Wilson | MATL:  | Wilson | TOLERANCE | Mason     | DATE     | 14.03.2017 | Customer: |
| APPD: | Schumi |      |        | FINISH | Jamy   |           | Sheet No. | 1 from 3 |            |           |

# EDCON-COMPONENTS



## Visual Effect of Surface

















Nickel - plated brass  
(Satin surface)



Stainless steel (Spiral surface)



Gold - plated brass (Satin surface)

|            |   |   |   |   |
|------------|---|---|---|---|
| Order Code | <br>A4   | <br>A3 | <br>A2   | <br>A1   |
| Order Code | <br>A8   | <br>A7 | <br>A6   | <br>A5   |
| Order Code | <br>B3   | <br>B2 | <br>B1   | <br>A9   |
| Order Code | <br>Bx | You can create our own symbol<br>Bx   | <br>B5 | <br>B4 |

|                                    |               |
|------------------------------------|---------------|
| <b>28MM Anti-Vandal-Pilot Lamp</b> |               |
| Part No.:                          | <b>Q35079</b> |
| Customer:                          |               |

|       |        |      |        |        |        |           |           |      |            |
|-------|--------|------|--------|--------|--------|-----------|-----------|------|------------|
| DRW:  | Jason  | CHKD | Wilson | MATL:  | Wilson | TOLERANCE | Mason     | DATE | 14.03.2017 |
| APPD: | Schumi |      |        | FINISH | Jamy   |           | Sheet No. |      | 2 from 3   |

# EDCON-COMPONENTS



## Ordering Informations

| Serie         | Front Shape | Contact Structure | Lamp Type | Connect Type | Lamp Color | Lamp Voltage | Crust Material | Engraving Options | ROHS     | Packing Style |
|---------------|-------------|-------------------|-----------|--------------|------------|--------------|----------------|-------------------|----------|---------------|
| <b>Q35079</b> | <b>F</b>    | <b>00</b>         | <b>D</b>  | <b>3</b>     | <b>A</b>   | <b>0</b>     | <b>S</b>       | <b>00</b>         | <b>R</b> | <b>N</b>      |

|                |  |                    |                        |                  |                                       |  |                        |                            |                              |
|----------------|--|--------------------|------------------------|------------------|---------------------------------------|--|------------------------|----------------------------|------------------------------|
| <b>F= Flat</b> |  | <b>D= DOT-Size</b> | <b>3= Pin Terminal</b> |                  | <b>0= with 0R Resistor before LED</b> | <b>S= Stainless Steel</b>                    | <b>00= No function</b> | <b>R= ROHS Conform</b>     | <b>N= White Carton</b>       |
|                |  |                    |                        | <b>R= Red</b>    |                                       |  |                        | <b>N= NON ROHS Conform</b> | <b>I= Individual Packing</b> |
|                |  |                    |                        | <b>G= Green</b>  |                                       | <b>N= Nickel Plated Brass</b>                |                        |                            |                              |
|                |  |                    |                        | <b>Y= Yellow</b> | <b>1= 6V AC/DC</b>                    | <b>G= Gold Plated Brass</b>                  |                        |                            |                              |
|                |  |                    |                        | <b>O= Orange</b> | <b>2= 12V AC/DC</b>                   |  |                        |                            |                              |
|                |  |                    |                        | <b>B= Blue</b>   | <b>3= 24V AC/DC</b>                   | <b>K= Zn-Alloy (colorized Button Black)</b>  |                        |                            |                              |
|                |  |                    |                        | <b>W= White</b>  | <b>4= 36V AC/DC</b>                   | <b>B= Zn-Alloy (colorized Button Bronze)</b> |                        |                            |                              |
|                |  |                    |                        |                  | <b>5= 48V AC/DC</b>                   |  |                        |                            |                              |
|                |  |                    |                        |                  | <b>6= 110V AC/DC</b>                  |  |                        |                            |                              |
|                |  |                    |                        |                  | <b>7= 230V AC/DC</b>                  |  |                        |                            |                              |
|                |  |                    |                        |                  | <b>X= can we make by order</b>        |  |                        |                            |                              |

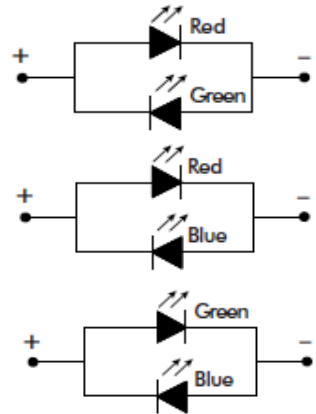
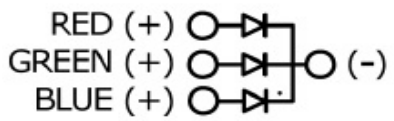

|                                    |
|------------------------------------|
| <b>28MM Anti-Vandal-Pilot Lamp</b> |
| Part No.: <b>Q35079</b>            |
| Customer:                          |

|       |        |      |        |        |        |           |           |      |            |
|-------|--------|------|--------|--------|--------|-----------|-----------|------|------------|
| DRW:  | Jason  | CHKD | Wilson | MATL:  | Wilson | TOLERANCE | Mason     | DATE | 14.03.2017 |
| APPD: | Schumi |      |        | FINISH | Jamy   |           | Sheet No. |      | 3 from 3   |