

EDCON-COMPONENTS



Contact



Specifications

Current Rating:	2,0 Ampere
Insulator Resistance:	1000 Megaohm min.
Contact Resistance	20m Ohm max.
Dielectric Withstanding:	AC 500V
Operating Temperature:	.-60°C to +125°C
Contact Material:	CopperAlloy
Insulator Material:	Polyester, UL 94V-0
Standard:	PBT
Contact Plating:	Tin, Gold or Selective Plated
Standard:	Gold Flash Overall

P.C.B Layout

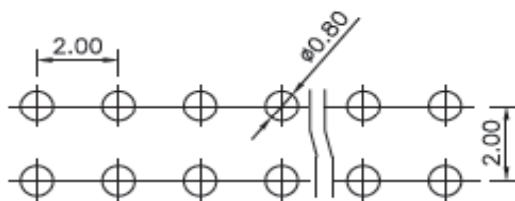

Drawing (mm)

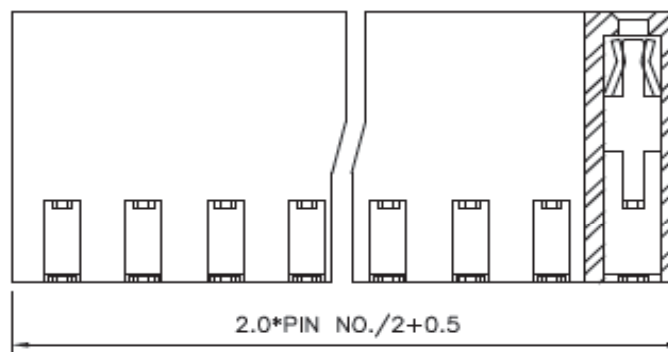
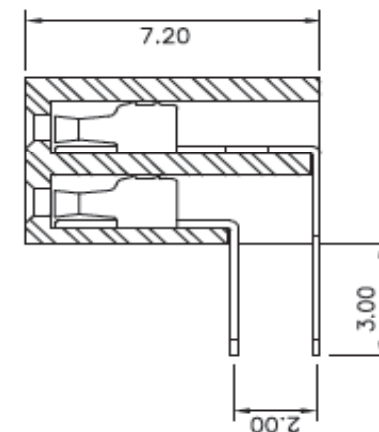
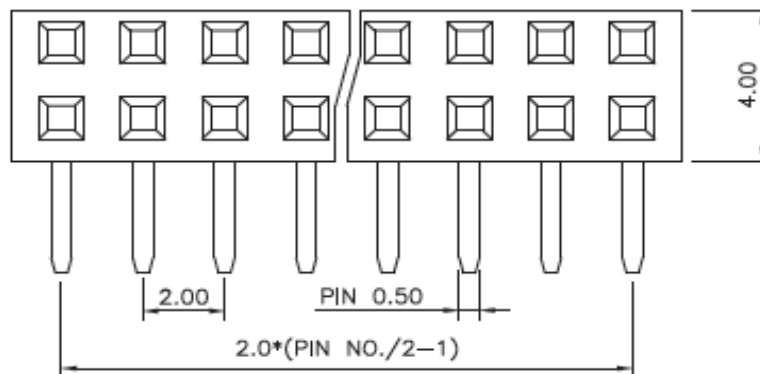

**Female Header Pitch
2,00mm**

Part No.: **T27B1109-**

Customer:

DRW:	Jason	CHKD	Wilson	MATL:	Wilson	TOLERANCE	Mason	DATE	05.03.2018
APPD:	Schumi			FINISH	Jamy		Sheet No.		1 from 4

EDCON-COMPONENTS



Contact



Pin Code length table free configuration Table 1

Drawing (mm)

Order Code	Dimension (mm)			
	D			
A01	3,00			
A02				
A03				
A04				
A05				
A06				
A07				
A08				
A09				
A10				
A11				
A12				
A13				
A14				
A15				
A16				
A17				
A18				
A19				
A20				
A21				
A22				
A23				
A24				
A25				
A26				
A27				

Female Header Pitch 2,00mm
Part No.: T27B1109-

DRW:	Jason	CHKD	Wilson	MATL:	Wilson	TOLERANCE	Mason	DATE	05.03.2018	Customer:
APPD:	Schumi			FINISH	Jamy		Sheet No.	2 from 4		

www.edcon-components.com

email: info@edcon-components.com

EDCON-COMPONENTS



Contact



Ordering Informations

Serie	No. of Pos.	Construction	Contact Plating	Material	Nose	Pin Length Code D	ROHS	Packing		
T27B1109-	XX	RT	G0	PB	N	A01	R	BU		

04 ~ 80Pos.	RT= Right angle THT	G0= Gold Flash (Standard)	PB= P.B.T	N= No	Look Table No. 1	N=NO ROHS conform	BU= Bulk (Standard)
		T0= Tin plated	NY= Nylon-6T	Y= Yes		R= ROHS conform	TU= Tube w/o Cap
		T0= Tin plated	PA= PA-46			TC= Tube w. pic and Place Cap	
		GA= 3µ Gold Plating				TY= Tray packing w/o Cap	
		GB= 5µ Gold Plating				TR= Tape/Reel w. pic and Place Cap	
		GC= 10µ Gold Plating					
		GD= 15µ Gold Plating					
		GE= 20µ Gold Plating					
		GF= 30µ Gold Plating					
		S0= Selectiv Plating Gold Flash / Tin					

Female Header Pitch 2,00mm	
Part No.:	T27B1109-
Customer:	

DRW:	Jason	CHKD	Wilson	MATL:	Wilson	TOLERANCE	Mason	DATE	05.03.2018
APPD:	Schumi			FINISH	Jamy		Sheet No.		3 from 4

EDCON-COMPONENTS

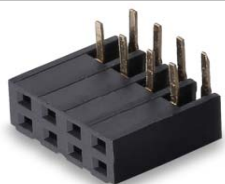

Contact



Soldering Profile for Lead Free Soldering (P.B.T.)

Soldering Profile for Lead Free Soldering (Nylon 6T)

Classification Reflow Profile (JEDEC J-STD-020C)

Classification Reflow Profile (JEDEC J-STD-020C)

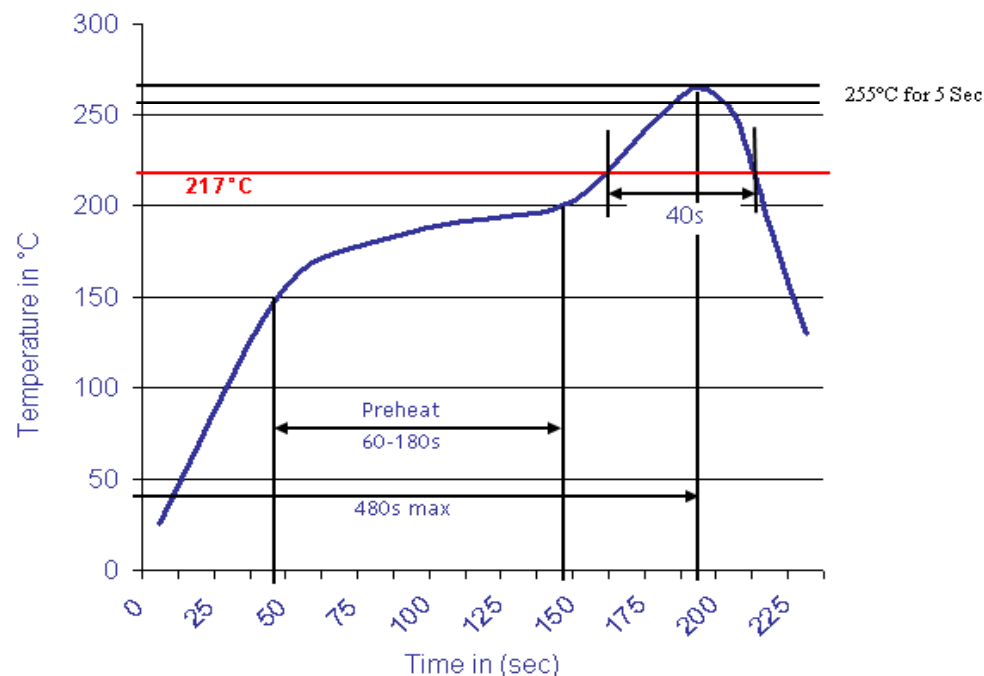
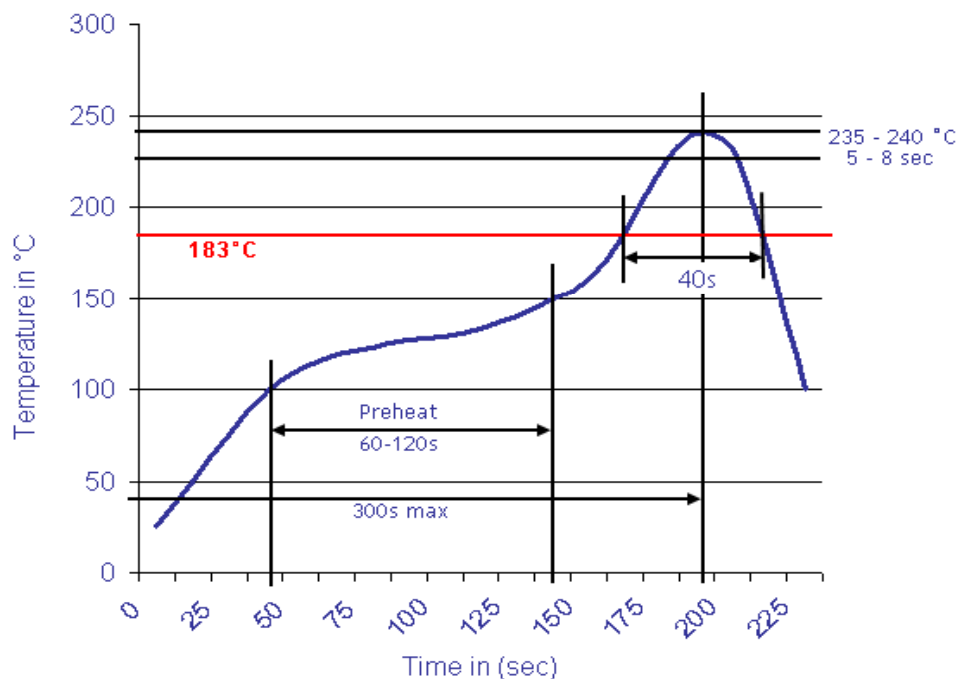

Female Header Pitch 2,00mm	
Part No.:	T27B1109-
Customer:	

DRW:	Jason	CHKD	Wilson	MATL:	Wilson	TOLERANCE	Mason	DATE	05.03.2018
APPD:	Schumi			FINISH	Jamy		Sheet No.		4 from 4

www.edcon-components.com

email: info@edcon-components.com