



DATA SHEET

Mikro Switch 19,8x9,8x6,5mm

Serie: Q19007

**Mikro Switch
19,8x9,8x6,5mm**

Serie No.: **Q19007**

Customer:

| | | | | | | | | | |
|-------|--------|------|--------|--------|--------|-----------|-----------|------|------------|
| DRW: | Jason | CHKD | Wilson | MATL: | Wilson | TOLERANCE | Mason | DATE | 21.09.2016 |
| APPD: | Schumi | | | FINISH | Jamy | | Sheet No. | | 1 from 6 |



Technical Dimensions

Electrical Specifications

Rated Voltage: 250VAC
 Rated Current: 10A
 Contact Resistance: ≤100mΩ
 Operating force: different force like order table
 Leg-Style: different leg-styles like table

Mechanical Specifications

Mechanical Life: 10.000.000 cycles
 Insulation Resistance: ≥ 100MΩ BC 500V
 Application Humidity: < 85% RH
 Dielectric Strength: AC1500V / 1Min.
 Operating Temperature: -25°C to +85°C / 125°C

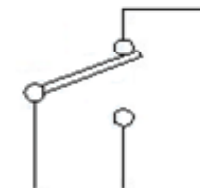
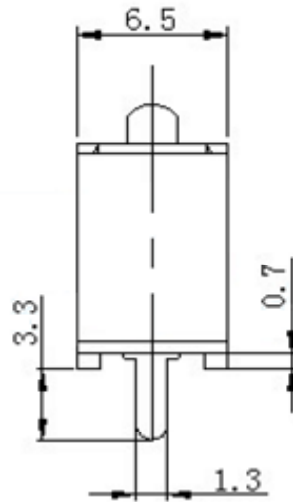
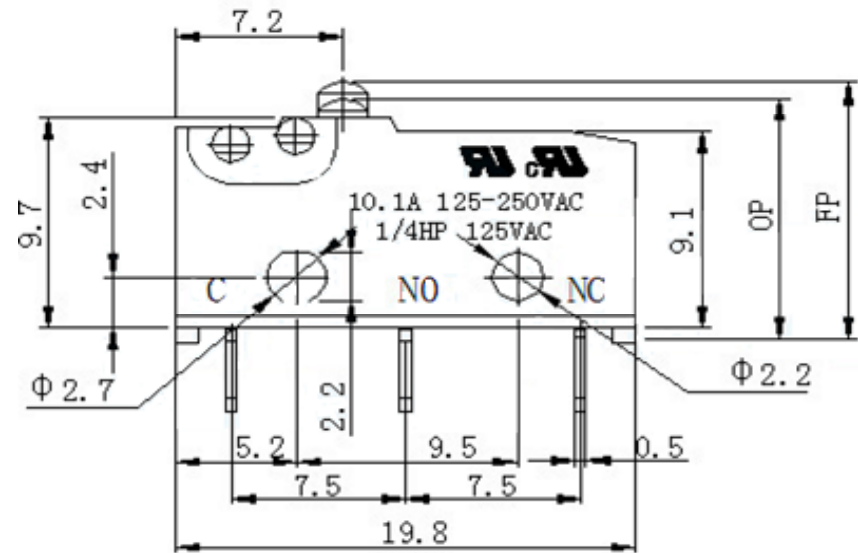

Schematic

| | |
|-----------------------|---------------|
| Mikro Switch | |
| 19,8x9,8x6,5mm | |
| Part No.: | Q19007 |
| Customer: | |

| | | | | | | | | | |
|-------|--------|------|--------|--------|--------|-----------|-----------|------|------------|
| DRW: | Jason | CHKD | Wilson | MATL: | Wilson | TOLERANCE | Mason | DATE | 01.07.2019 |
| APPD: | Schumi | | | FINISH | Jamy | | Sheet No. | | 2 from 6 |

EDCON-COMPONENTS



LEG-Style

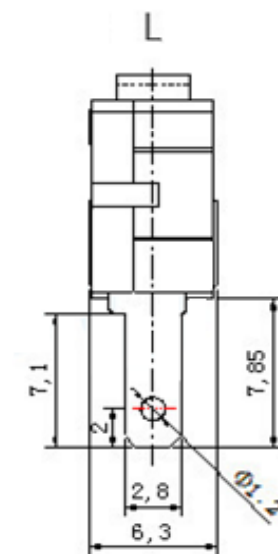
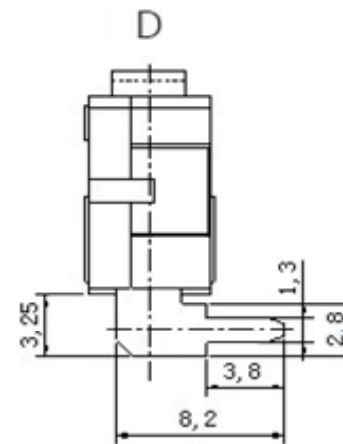
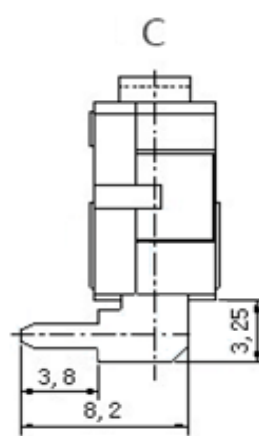
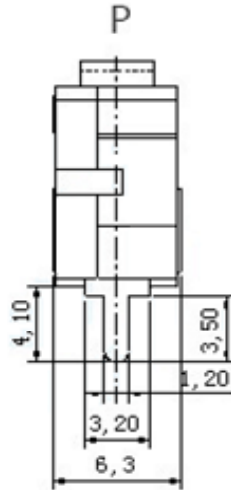
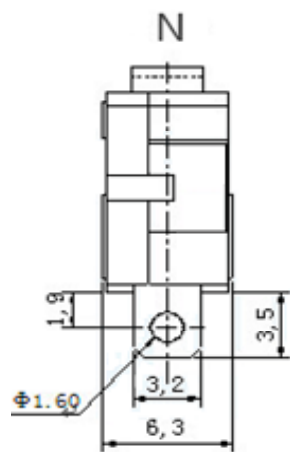

**Mikro Switch
19,8x9,8x6,5mm**

Part No.: **Q19007**

Customer:

| | | | | | | | | | |
|-------|--------|------|--------|--------|--------|-----------|-----------|----------|------------|
| DRW: | Jason | CHKD | Wilson | MATL: | Wilson | TOLERANCE | Mason | DATE | 01.07.2019 |
| APPD: | Schumi | | | FINISH | Jamy | | Sheet No. | 3 from 6 | |

EDCON-COMPONENTS



Operating and handle Shape and Dimensions

Lever Type A

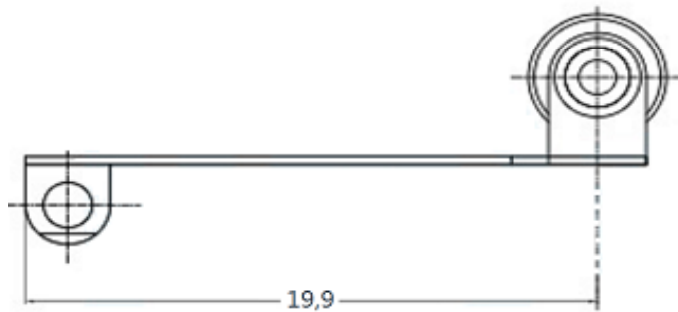

Lever Type C

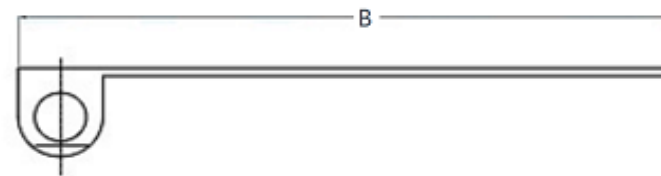

Mikro Switch
19,8x9,8x6,5mm

Part No.: **Q19007**

| | | | | | | | | | |
|-------|--------|------|--------|--------|--------|-----------|-----------|------|------------|
| DRW: | Jason | CHKD | Wilson | MATL: | Wilson | TOLERANCE | Mason | DATE | 01.07.2019 |
| APPD: | Schumi | | | FINISH | Jamy | | Sheet No. | | 4 from 6 |

Customer:

www.edcon-components.com

email: info@edcon-components.com

EDCON-COMPONENTS



Ordering Informations

| Serie | Operating force | Termination | Power Rating | Lever | Length of Lever C (B) | Special function | Special function | ROHS | Packing Code | |
|-------|-----------------|-------------|--------------|-------|-----------------------|------------------|------------------|------|--------------|--|
|-------|-----------------|-------------|--------------|-------|-----------------------|------------------|------------------|------|--------------|--|

| | | | | | | | | | | |
|---------------|------------|----------|-----------|-----------|-----------|----------|----------|----------|-----------|--|
| Q19007 | 100 | P | B1 | N0 | 00 | A | N | R | BU | |
|---------------|------------|----------|-----------|-----------|-----------|----------|----------|----------|-----------|--|

| | | | | | | | | | |
|-------------------|-----------------------------------|----------------|---------------------------|-----------------------|----------------------------|-----------------------|----------------------------|-------------------------|--|
| 251= 250gr | P= PCB Solder Straight Pin | B1= 10A | N0= Non Lever | 00= without | A= -40°C to + 85°C | N= No function | R= ROHS Conform | BU= Bulk Ware | |
| 080= 80gr | N= 2,8mm Flat Terminal | | A1= Lever Style A1 | 40= B= 40mm | B= -40°C to + 125°C | | N= NON ROHS Conform | TY= Tray Packing | |
| 070= 70gr | C= PCB Angle Left Side | | C1= Lever Style C1 | 21= B= 21,6mm | | | | | |
| | D= PCB Angle Right Side | | | 28= B= 28,45mm | | | | | |
| | L= 2,8mm Flat Terminal | | | 18= B= 18,8mm | | | | | |
| | | | | 14= B= 14,5mm | | | | | |

| | |
|--|---------------|
| Mikro Switch 19,8x9,8x6,5mm | |
| Part No.: | Q19007 |
| Customer: | |

| | | | | | | | | | |
|-------|--------|------|--------|--------|--------|-----------|-----------|------|------------|
| DRW: | Jason | CHKD | Wilson | MATL: | Wilson | TOLERANCE | Mason | DATE | 01.07.2019 |
| APPD: | Schumi | | | FINISH | Jamy | | Sheet No. | | 5 from 6 |



Soldering Profile Curve

Classification Reflow Profile (JEDEC J-STD-020C)

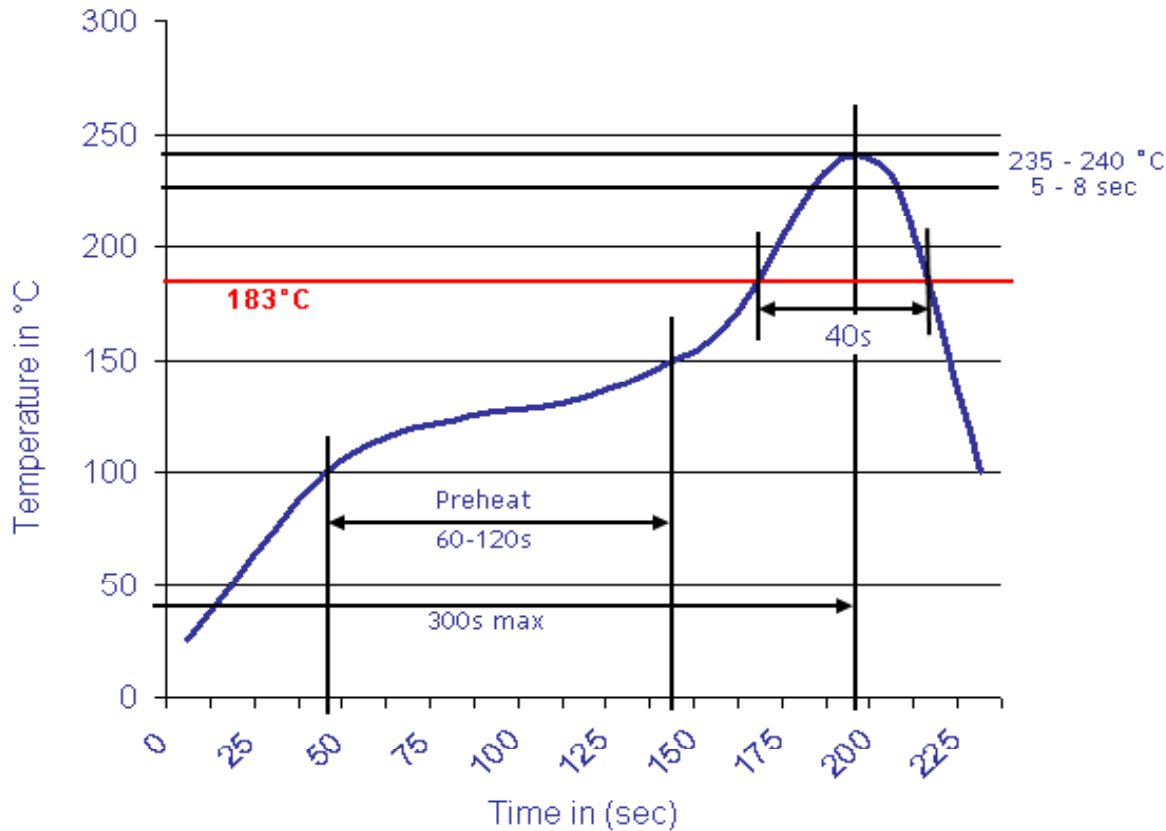

| | |
|-----------------------|---------------|
| Mikro Switch | |
| 19,8x9,8x6,5mm | |
| Part No.: | Q19007 |
| Customer: | |

| | | | | | | | | | |
|-------|--------|------|--------|--------|--------|-----------|-----------|----------|------------|
| DRW: | Jason | CHKD | Wilson | MATL: | Wilson | TOLERANCE | Mason | DATE | 01.07.2019 |
| APPD: | Schumi | | | FINISH | Jamy | | Sheet No. | 6 from 6 | |