

EDCON-COMPONENTS



Specifications

Switch Rating:	5A/250VAC
Contact Configuration:	1NO1NC / 2NO2NC
Operating Type:	Momentary / Latching function
IP-Degree:	IP65
Crust Material:	like ordering code
Terminal Type:	Solder Lug (2,8x0,5mm)
Switching:	ON / OFF
Contact Resistance:	≤ 50mΩ
Insulation Resistance:	≥ 1000MΩ
Dielectric Strength:	2000VAC
Operating Temperature:	-20°C ~ +55°C
Mechanical Life:	1.000.000 cycles
Electrical Life:	50.000 cycles
Panel Thickness:	1 ~ 10mm
Torque:	5 ~ 14Nm
Operating Pressure:	About 5,5-7Nm
Operating Distance:	About 2,8mm

Material

Contact:	Silver Alloy												
Button:	Stainless Steel												
Body:	Stainless Steel												
Base:	PA												
ROHS:	Made to Order-Code												
Type:	Illuminated (LED)												
Color:	<table border="0"> <tr> <td>R</td> <td>Y</td> <td>O</td> <td>G</td> <td>B</td> <td>W</td> </tr> <tr> <td>AC/DC 1,7V</td> <td></td> <td></td> <td>AC/DC 2,8V</td> <td></td> <td></td> </tr> </table>	R	Y	O	G	B	W	AC/DC 1,7V			AC/DC 2,8V		
R	Y	O	G	B	W								
AC/DC 1,7V			AC/DC 2,8V										
Rated Voltage:	AC/DC 1,7V												
Rated Current:	20mA												
Lifetime:	40000Hrs												

Drawing

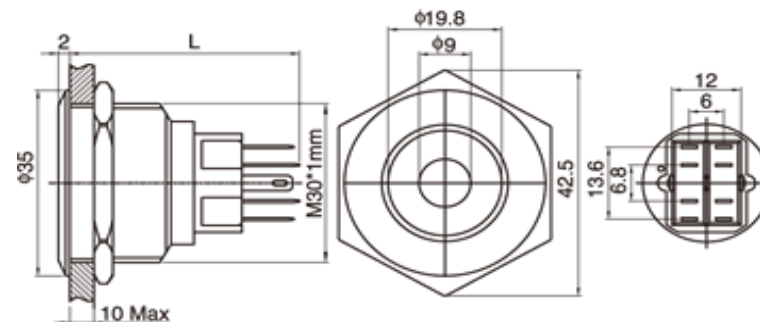

L= Momentary Function 35,5mm

L= Latching function = 40mm

Current Limiting Resistance Configuration Table

Operating Voltage (U)	6V	12V	24V	36V
R Y O	210Ω, 1/4W	510Ω, 1/4W	1,2KΩ, 1/4W	2,2KΩ, 1/4W
G B W	160Ω, 1/4W	470Ω, 1/4W	1,2KΩ, 1/4W	2,2KΩ, 1/4W

Formula	
R=	$\frac{U - U_e}{I_e}$

30MM Anti-Vandal-Switch
Part No.: Q35042

DRW:	Jason	CHKD	Wilson	MATL:	Wilson	TOLERANCE	Mason	DATE	14.03.2017	Customer:
APPD:	Schumi			FINISH	Jamy		Sheet No.	1 from 3		

EDCON-COMPONENTS



Visual Effect of Surface

















Nickel - plated brass
(Satin surface)



Stainless steel (Spiral surface)



Gold - plated brass (Satin surface)

Order Code	 A4	 A3	 A2	 A1
Order Code	 A8	 A7	 A6	 A5
Order Code	 B3	 B2	 B1	 A9
Order Code	 Bx	You can create our own symbol Bx	 B5	 B4

30MM Anti-Vandal-Switch

Part No.: **Q35042**

DRW:	Jason	CHKD	Wilson	MATL:	Wilson	TOLERANCE	Mason	DATE	14.03.2017	Customer:
APPD:	Schumi			FINISH	Jamy		Sheet No.	2 from 3		

EDCON-COMPONENTS



Ordering Informations

Serie	Front Shape	Contact Structure	Lamp Type	Connect Type	Lamp Color	Lamp Voltage	Crust Material	Engraving Options	ROHS	Packing Style
Q35042	F	10	D	3	A	0	S	00	R	N

F= Flat	11= 1NO1NC Momentary	D= Dot Size 	3= 2,8x0,5 Terminal	A= No Function	0= with 0R Resistor before LED 1= 6V AC/DC 2= 12V AC/DC 3= 24V AC/DC 4= 36V AC/DC 5= 48V AC/DC 6= 110V AC/DC 7= 230V AC/DC X= can we make by order	S= Stainless Steel N= Nickel Plated Brass G= Gold Plated Brass K= Zn-Alloy (colorized Button Black) B= Zn-Alloy (colorized Button Bronze)	00= No function	R= Red	R= ROHS Conform N= NON ROHS Conform I= Individual Packing
	22= 2NO2NC Momentary			R= Red					
	33= 1NO1NC Latching function			G= Green					
	44= 2NO2NC Latching function			Y= Yellow					
				O= Orange					
				B= Blue					
				W= White					
				P= Dual LED Red/Green					
				Z= Dual LED Red/Blue					
				Y= Dual LED Green/Blue					
				T= RGB-LED Tripple Colour					

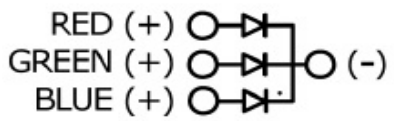

30MM Anti-Vandal-Switch
Part No.: **Q35042**

DRW:	Jason	CHKD	Wilson	MATL:	Wilson	TOLERANCE	Mason	DATE	14.03.2017	Customer:
APPD:	Schumi			FINISH	Jamy		Sheet No.	3 from 3		