

# EDCON-COMPONENTS

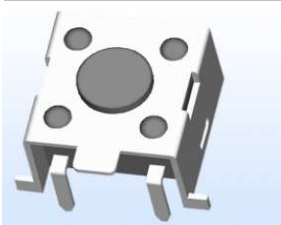

## SPECIFICATION:

Current Rating:	50mA / 12VDC
Insulator Resistance:	100 Megaohm min.
Dielectric Withstanding:	AC 250V
Operating Temperature:	.-30°C to +85°C
Travel:	0,45mm ± 0,1mm
Insulator Material:	Nylon
Cover:	PBS-Strip
Contact Plating:	Stainless Steel Silver plated
Terminal:	Brass Silver plated
Contact Resistance:	100mΩ max.

## PCB Layout

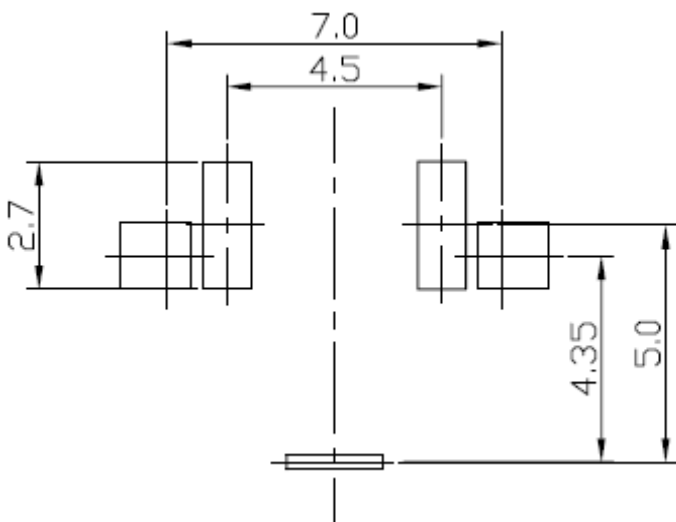

## Drawing

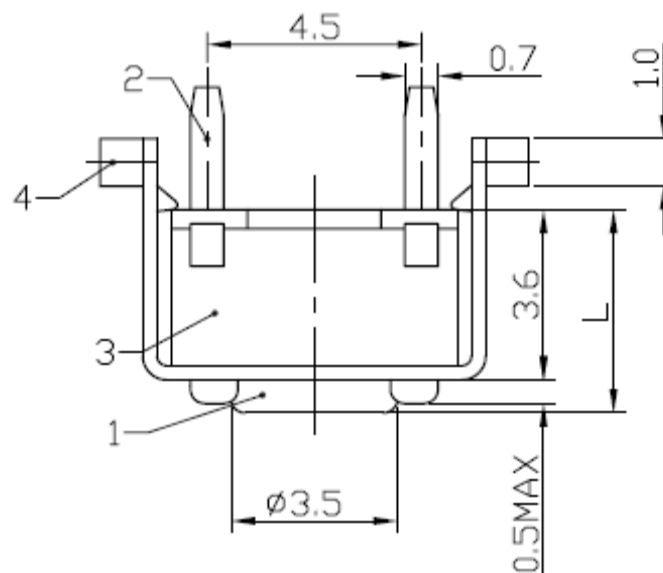

**SMT TACT SWITCH**  
**7,2x7,5mm**

Part No.: **Q12133**

Customer:

DRW:	Jason	CHKD	Wilson	MATL:	Wilson	TOLERANCE	Mason	DATE	16.02.2015
APPD:	Schumi			FINISH	Jamy		Sheet No.	1 from 4	



# EDCON-COMPONENTS

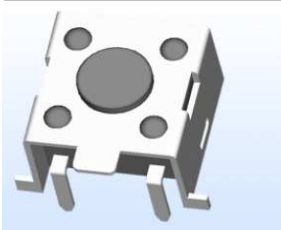

## Ordering Informations

Serie	Total height w. Body	Fill with 0	Operating Force	Polarisation Peg	Electrical life	Fill with 0	ROHS	Packing		
<b>Q12133</b>	<b>043</b>	<b>X</b>	<b>231</b>	<b>N</b>	<b>104</b>	<b>X</b>	<b>R</b>	<b>BU</b>		

xxx= Look Knob Order Code L	X= no function	231= 230gr	N= without Peg	104= 100000 cycles	X= no function	N= non ROHS	BU= Bulk Ware
		331= 330gr				R= ROHS conform	

**SMT TACT SWITCH  
7,2x7,5mm**

Part No.: **Q12133**

DRW:	Jason	CHKD	Wilson	MATL:	Wilson	TOLERANCE	Mason	DATE	16.02.2015
APPD:	Schumi			FINISH	Jamy			Sheet No.	3 from 4

Customer:

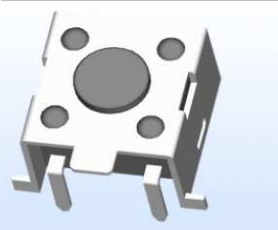

Soldering Profile for Lead Soldering

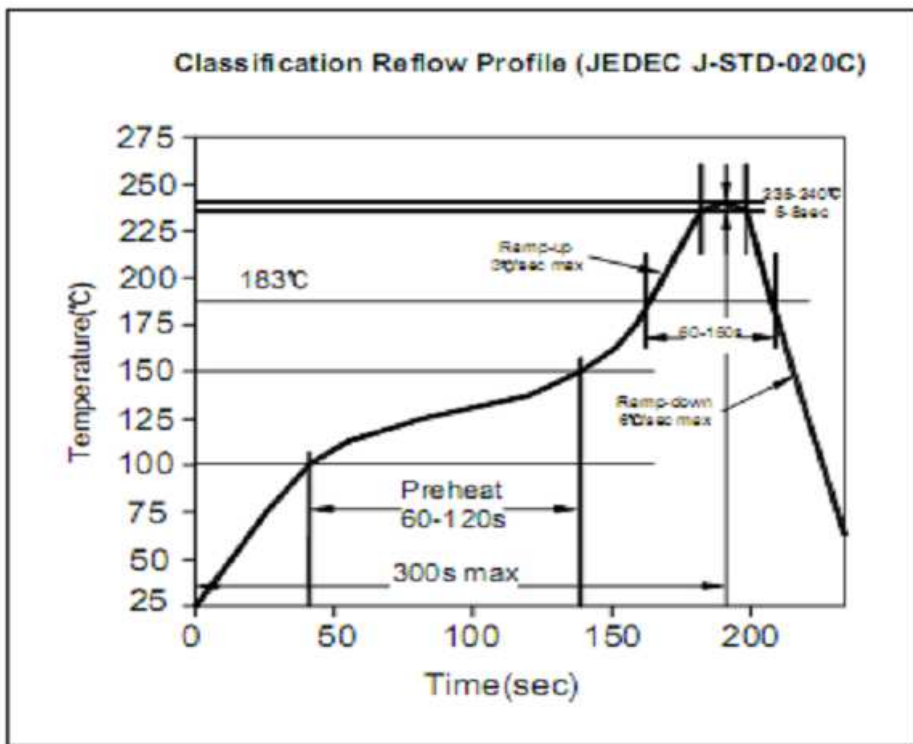

Soldering Profile for Lead Free Soldering

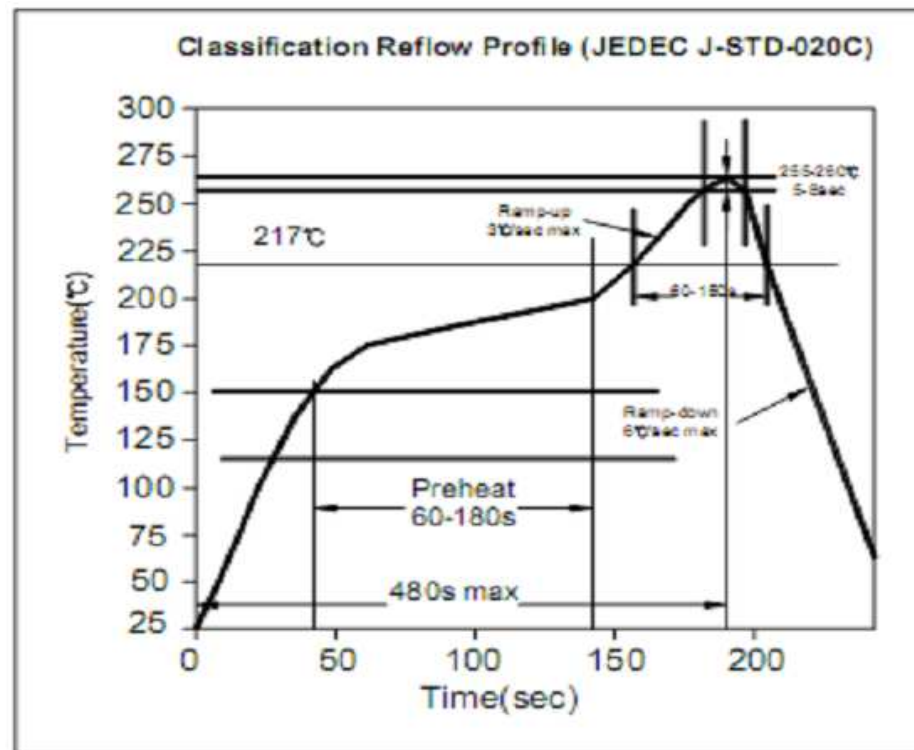

**SMT TACT SWITCH  
7,2x7,5mm**

Part No.: **Q12133**

DRW:	Jason	CHKD	Wilson	MATL:	Wilson	TOLERANCE	Mason	DATE	16.02.2015
APPD:	Schumi			FINISH	Jamy		Sheet No.	4 from 4	Customer: