

Technical Dimension

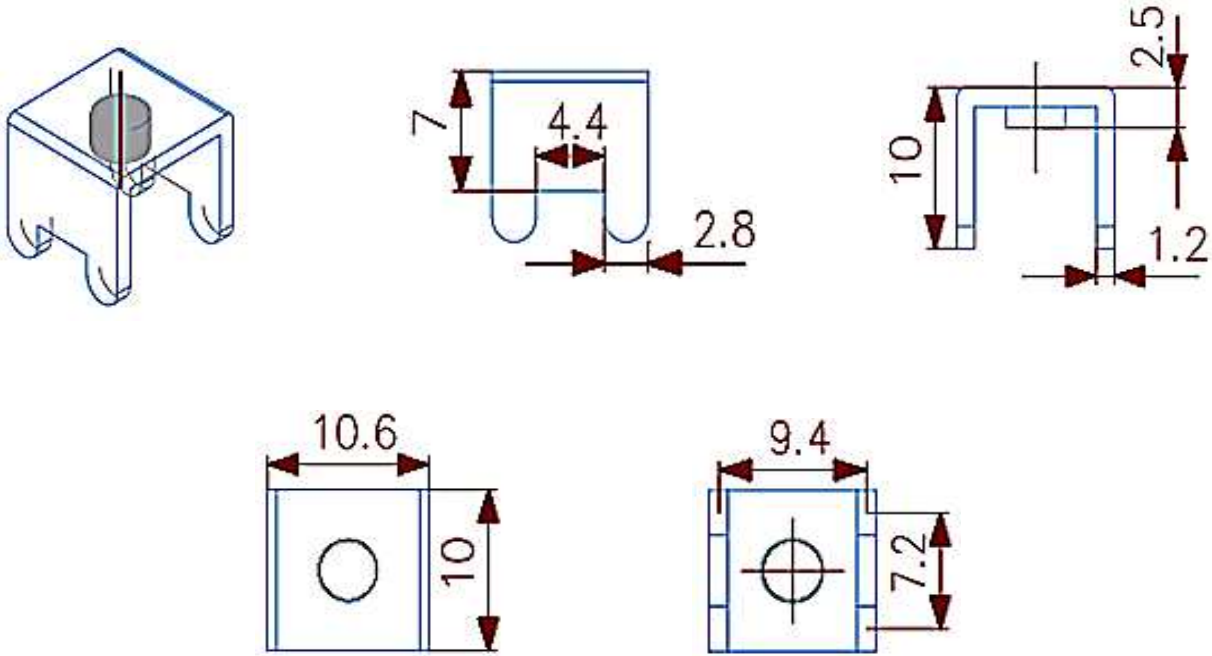

Material

Material: Brass, Tin plated
 Screw-Size: M5
 Rated Current: 80A

Ordering Information

Serie	Thread-Size	Plating	Special	ROHS	Packing
A25127	M5	TN	N	R	BU

M5= Thread Size	TN= tin plated	R= ROHS Conform	N= NON ROHS	BU= Bulk Ware

PCB Power Terminal	
Part No.:	A25127
Customer:	

DRW:	Jason	CHKD	Jules	MATL:	Wu	DATE	21.11.2017
APPD:	Join			FINISH	Shieh	Sheet	1 from 1