

Technical Dimension

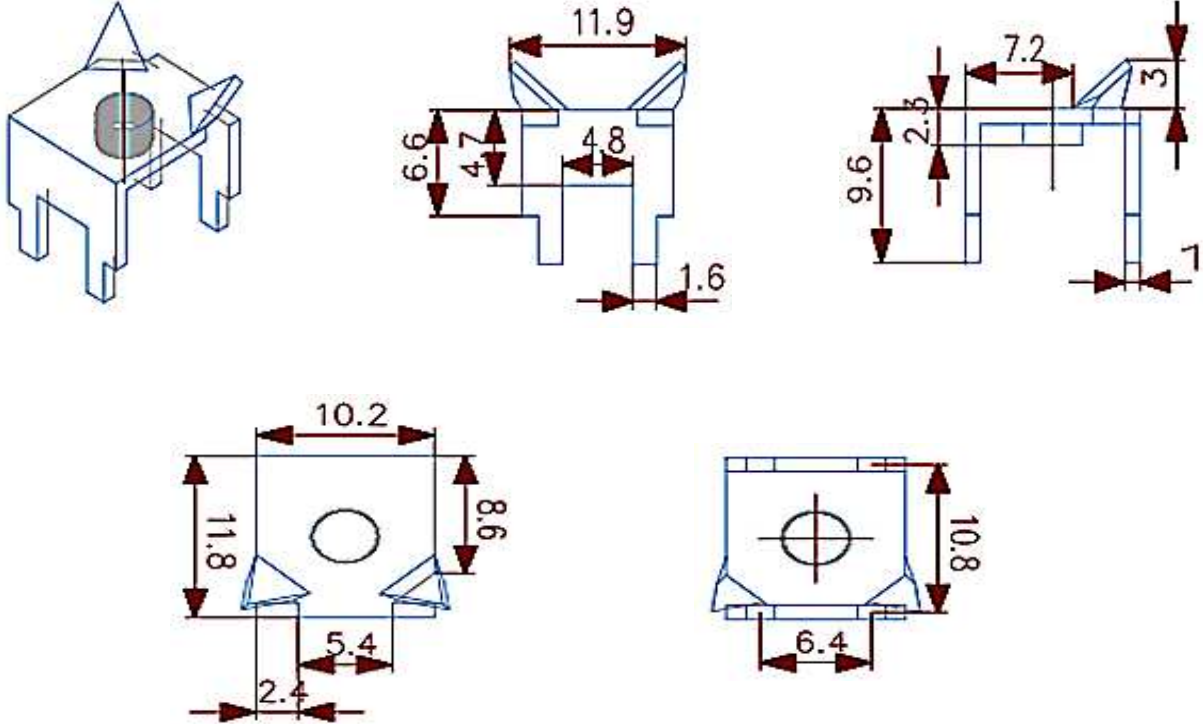

Material

Material: Brass, Tin plated
 Screw-Size: M4
 Rated Current: 45A

Ordering Information

Serie	Thread-Size	Plating	Special	ROHS	Packing
A25123	M4	TN	N	R	BU

M4= Thread Size	TN= tin plated	R= ROHS Conform	BU= Bulk Ware
		N= NON ROHS	

PCB Power Terminal	
Part No.:	A25123
Customer:	

DRW:	Jason	CHKD	Jules	MATL:	Wu	DATE	21.11.2017
APPD:	Join			FINISH	Shieh	Sheet	1 from 1