

**Technical Dimension**

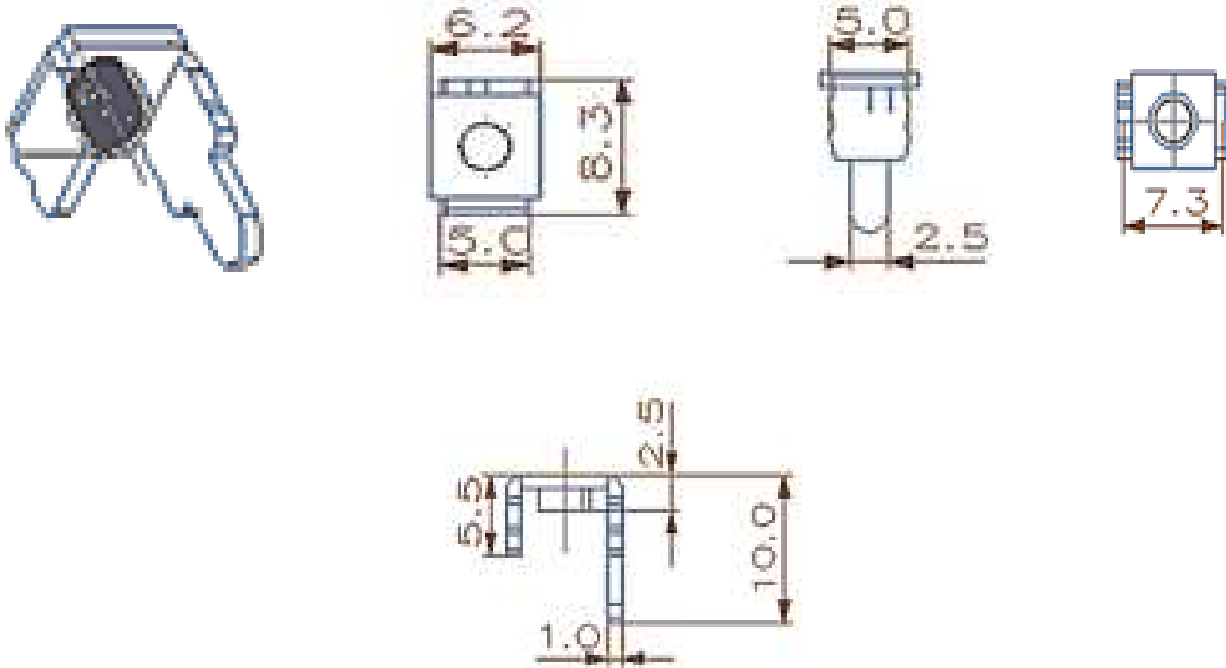

**Material**

Material: Brass, Tin plated  
 Screw-Size: M3  
 Rated Current: 18A

**Ordering Information**

Serie	Thread-Size	Plating	Special	ROHS	Packing
A25077	M3	TN	N	R	BU

M3= Thread Size	TN= tin plated	N= No function	R= ROHS Conform	BU= Bulk Ware
			N= NON ROHS	

<b>PCB Power Terminal</b>	
Part No.:	<b>A25077</b>
Customer:	

DRW:	Jason	CHKD	Jules	MATL:	Wu	DATE	21.11.2017
APPD:	Join			FINISH	Shieh	Sheet	1 from 1