

# EDCON-COMPONENTS



## Specifications

Switch Rating: 5A/250VAC  
 Contact Configuration: 1NO+1NC to 3NO+3NC

IP-Degree: IP65 / IK08  
 Crust Material: Stainless Steel  
 Terminal Type: Look order Code  
 Switching: Self Locking  
 Contact Resistance:  $\leq 50\text{m}\Omega$   
 Insulation Resistance:  $\geq 1000\text{M}\Omega$   
 Dielectric Strength: 2000VAC  
 Operating Temperature:  $-20^{\circ}\text{C} \sim +55^{\circ}\text{C}$   
 Mechanical Life: 500.000 cycles  
 Electrical Life: 50.000 cycles  
 Panel Thickness: 1 ~ 10mm  
 Nut Torque: 5 ~ 14Nm  
 Operating Pressure: About 4N

Operating Stroke: About 1,8mm

## Material

Contact: Silver Alloy  
 Button: Look order Code  
 Body: Look order Code  
 Base: PA66  
**ROHS:** Made by Order-Code

## Drawing

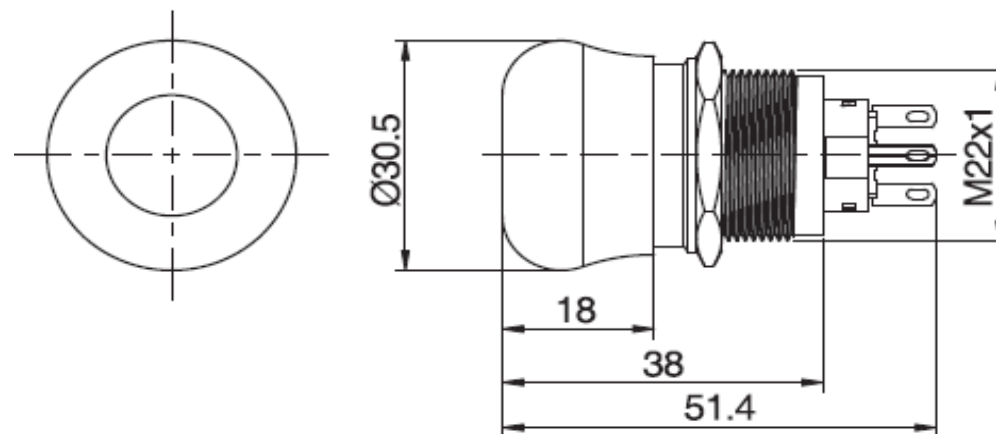

**22MM Anti-Vandal-  
Emergency Switch**

Part No.: **Q36101**

DRW:	Jason	CHKD	Wilson	MATL:	Wilson	TOLERANCE	Mason	DATE	06.08.2017	Customer:
APPD:	Schumi			FINISH	Jamy		Sheet No.	1 from 3		

# EDCON-COMPONENTS



## Visual Effect of Surface



Nickel - plated brass  
( Satin surface)



Stainless steel ( Spiral surface)



Gold - plated brass ( Satin surface)



G=Gray



B=Black



W=White

## Engraving Options

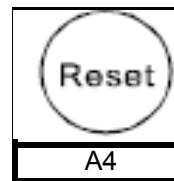

Order Code

A4

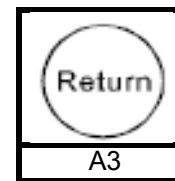

A3

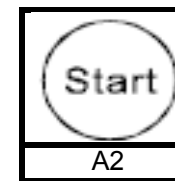

A2

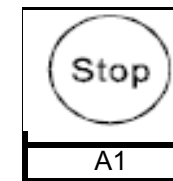

A1

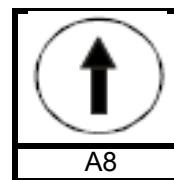

Order Code

A8

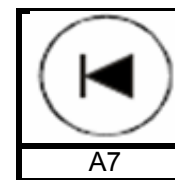

A7

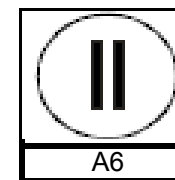

A6

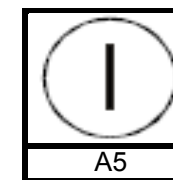

A5

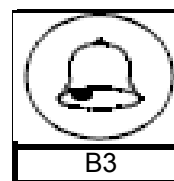

Order Code

B3

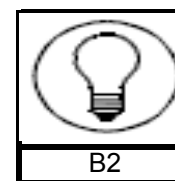

B2

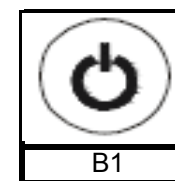

B1

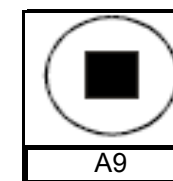

A9

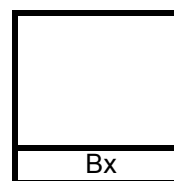

Order Code

Bx

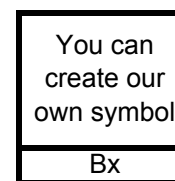

Bx

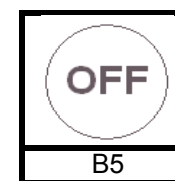

B5

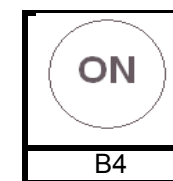

B4

**22MM Anti-Vandal-Emergency Switch**

Part No.: **Q36101**

DRW:	Jason	CHKD	Wilson	MATL:	Wilson	TOLERANCE	Mason	DATE	06.08.2017	Customer:
APPD:	Schumi			FINISH	Jamy		Sheet No.		2 from 3	

# EDCON-COMPONENTS



## Ordering Information

Serie	Front Shape	Contact Structure	Switch Function	Connect Type	Knob Color	Lamp Voltage	Crust Material	Engraving Options	ROHS	Packing Style
<b>Q36101</b>	<b>E</b>	<b>11</b>	<b>S</b>	<b>2</b>	<b>R</b>	<b>0</b>	<b>S</b>	<b>00</b>	<b>R</b>	<b>N</b>
			<b>S=</b> Self Locking	<b>1=</b> Solder Lug 2,8x0,5mm		<b>0=</b> without	<b>S=</b> Stainless Steel		<b>R=</b> ROHS Conform	<b>N=</b> Carton
		<b>11=</b> 1NO1NC						<b>00=</b> No function	<b>N=</b> NON ROHS Conform	<b>I=</b> Individual Packing
	<b>E=</b> Emergency	<b>22=</b> 2NO2NC								
		<b>33=</b> 3NO3NC								
					<b>R=</b> Red					

<b>22MM Anti-Vandal-Emergency Switch</b>	
Part No.:	<b>Q36101</b>
Customer:	

DRW:	Jason	CHKD	Wilson	MATL:	Wilson	TOLERANCE	Mason	DATE	06.08.2017
APPD:	Schumi			FINISH	Jamy		Sheet No.		3 from 3