

EDCON-COMPONENTS



Specifications

IP-Degree: IP65 / IK08
 Crust Material: Look order Code
 Terminal Type: Look order Code

Insulation Resistance: $\geq 1000M\Omega$
 Dielectric Strength: 2000VAC
 Operating Temperature: $-20^{\circ}C \sim +55^{\circ}C$

Panel Thickness: 1 ~ 10mm
 Nut Torque: 5 ~ 14Nm

Drawing

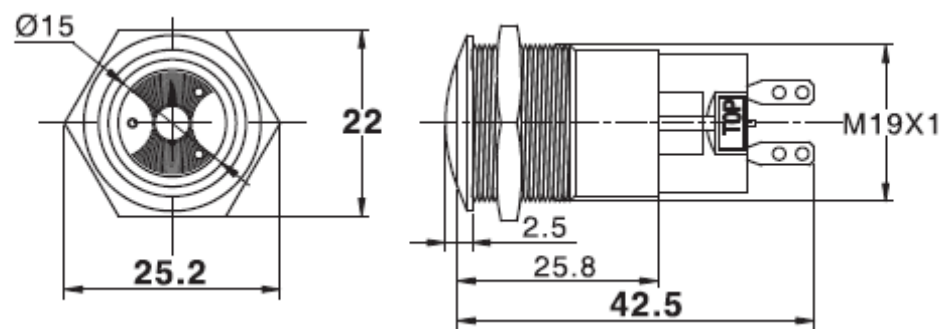

Material

Contact: Silver Alloy
 Button: Look order Code
 Body: Look order Code
 Base: PA66
ROHS: Made by Order-Code

19MM Anti-Vandal-Buzzer

Part No.: **Q36096**

DRW:	Jason	CHKD	Wilson	MATL:	Wilson	TOLERANCE	Mason	DATE	06.08.2017	Customer:
APPD:	Schumi			FINISH	Jamy		Sheet No.	1 from 3		

EDCON-COMPONENTS



Visual Effect of Surface



Nickel - plated brass
(Satin surface)



Stainless steel (Spiral surface)



Gold - plated brass (Satin surface)



G=Gray



B=Black



W=White

Engraving Options

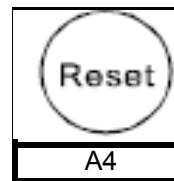

Order Code

A4

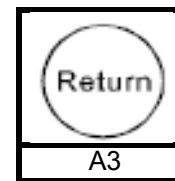

A3

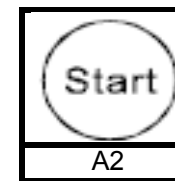

A2

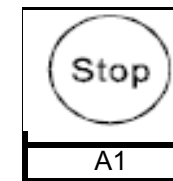

A1

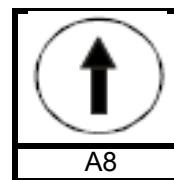

Order Code

A8

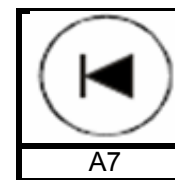

A7

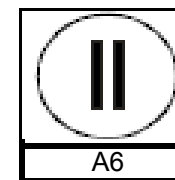

A6

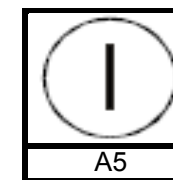

A5

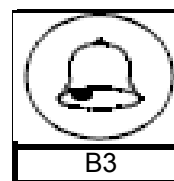

Order Code

B3

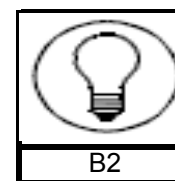

B2

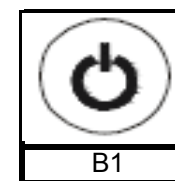

B1

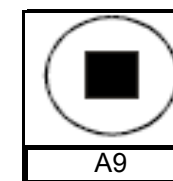

A9

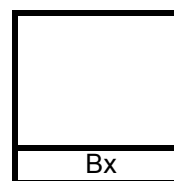

Order Code

Bx

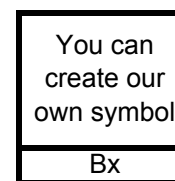

You can create our own symbol

Bx

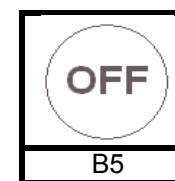

OFF

B5

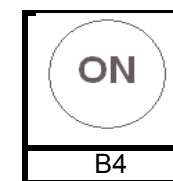

ON

B4

19MM Anti-Vandal-Buzzer

Part No.: **Q36096**

DRW:	Jason	CHKD	Wilson	MATL:	Wilson	TOLERANCE	Mason	DATE	06.08.2017	Customer:
APPD:	Schumi			FINISH	Jamy		Sheet No.		2 from 3	

EDCON-COMPONENTS



Ordering Information

Serie	Front Shape	Contact Structure	Switch Function	Connect Type	Knob Color	Lamp Voltage	Crust Material	Engraving Options	ROHS	Packing Style
Q36096	D	00	00	2	0	0	N	00	R	N
	B= Domed		00= No function	1= Solder Lug 2,8x0,5mm	0= Same us Body	0= without	S= Stainless Steel N= Nickel Plated Brass G= Gold Plated Brass	00= No function	R= ROHS Conform N= NON ROHS Conform	N= Carton I= Individual Packing
	00= No function									

19MM Anti-Vandal-Buzzer	
Part No.:	Q36096
Customer:	

DRW:	Jason	CHKD	Wilson	MATL:	Wilson	TOLERANCE	Mason	DATE	06.08.2017
APPD:	Schumi			FINISH	Jamy		Sheet No.		3 from 3