

EDCON-COMPONENTS



Specifications

Switch Rating: 5A/250VAC
 Contact Configuration: 1NO+1NC to 4NO+4NC

 IP-Degree: IP65 / IK08
 Crust Material: Look order Code
 Terminal Type: Look order Code
 Switching: Momentary / Self Locking
 Contact Resistance: $\leq 50\text{m}\Omega$
 Insulation Resistance: $\geq 1000\text{M}\Omega$
 Dielectric Strength: 2000VAC
 Operating Temperature: $-20^{\circ}\text{C} \sim +55^{\circ}\text{C}$
 Mechanical Life: 500.000 cycles
 Electrical Life: 50.000 cycles
 Panel Thickness: 1 ~ 10mm
 Nut Torque: 5 ~ 14Nm
 Operating Pressure: About 4N

Operating Stroke: About 1,8mm

Material

Contact: Silver Alloy
 Button: Look order Code
 Body: Look order Code
 Base: PA66
ROHS: Made by Order-Code

Drawing

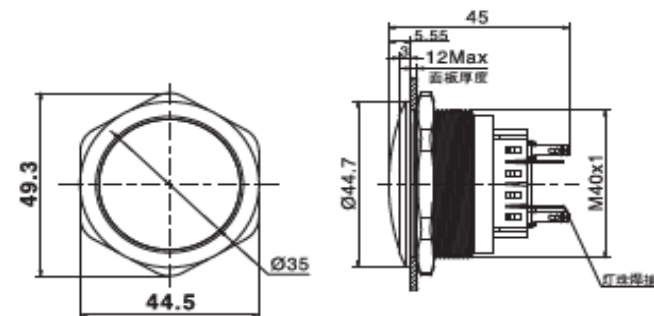

40MM Anti-Vandal-Switch

Part No.: **Q36095**

DRW:	Jason	CHKD	Wilson	MATL:	Wilson	TOLERANCE	Mason	DATE	06.08.2017	Customer:
APPD:	Schumi			FINISH	Jamy		Sheet No.	1 from 3		

EDCON-COMPONENTS



Visual Effect of Surface



Nickel - plated brass
(Satin surface)



Stainless steel (Spiral surface)



Gold - plated brass (Satin surface)



G=Gray



B=Black



W=White

Engraving Options

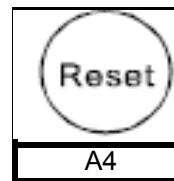

Order Code

A4

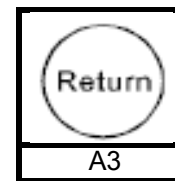

A3

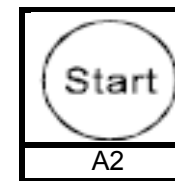

A2

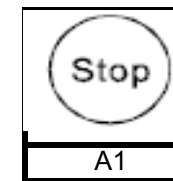

A1

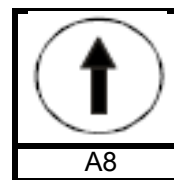

Order Code

A8

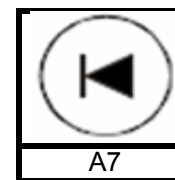

A7

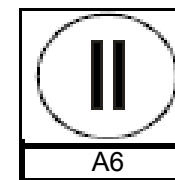

A6

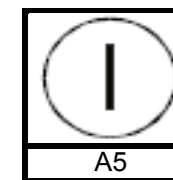

A5

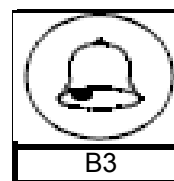

Order Code

B3

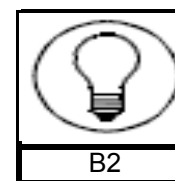

B2

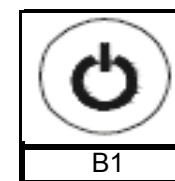

B1

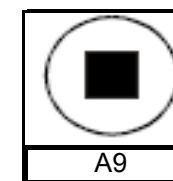

A9

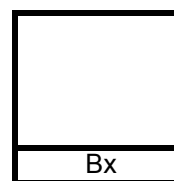

Order Code

Bx

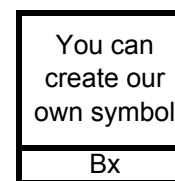

You can create our own symbol

Bx

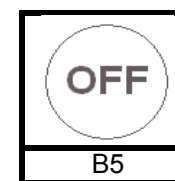

B5

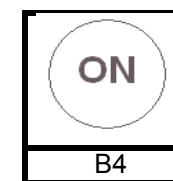

B4

40MM Anti-Vandal-Switch

Part No.: **Q36095**

DRW:	Jason	CHKD	Wilson	MATL:	Wilson	TOLERANCE	Mason	DATE	06.08.2017	Customer:
APPD:	Schumi			FINISH	Jamy		Sheet No.		2 from 3	

EDCON-COMPONENTS



Ordering Information

Serie	Front Shape	Contact Structure	Switch Function	Connect Type	Knob Color	Lamp Voltage	Crust Material	Engraving Options	ROHS	Packing Style
Q36095	D	11	M	2	0	0	N	XX	R	N
	B= Domed	11= 1NO1NC	M= Momentary S= Self Locking	1= Solder Lug 2,8x0,5mm	0= Same us Body	0= without	S= Stainless Steel N= Nickel Plated Brass G= Gold Plated Brass	XX= w/o other Look Order Code Engraving Options	R= ROHS Conform N= NON ROHS Conform	N= Carton I= Individual Packing
		22= 2NO2NC								
		33= 3NO3NC								
		44= 4NO4NC								

40MM Anti-Vandal-Switch	
Part No.:	Q36095
Customer:	

DRW:	Jason	CHKD	Wilson	MATL:	Wilson	TOLERANCE	Mason	DATE	06.08.2017
APPD:	Schumi			FINISH	Jamy		Sheet No.		3 from 3