

# EDCON-COMPONENTS



## Specifications

Switch Rating:	5A/250VAC
Contact Configuration:	1NO+1NC to 4NO+4NC
IP-Degree:	IP65 / IK08
Crust Material:	Look order Code
Terminal Type:	Look order Code
Switching:	Momentary / Self Locking
Contact Resistance:	≤ 50mΩ
Insulation Resistance:	≥ 1000MΩ
Dielectric Strength:	2000VAC
Operating Temperature:	. -20°C ~ +55°C
Mechanical Life:	500.000 cycles
Electrical Life:	50.000 cycles
Panel Thickness:	1 ~ 10mm
Nut Torque:	5 ~ 14Nm
Operating Pressure:	About 4N
Operating Stroke:	About 1,8mm

## Material

Contact:	Silver Alloy
Button:	Look order Code
Body:	Look order Code
Base:	PA66
<b>ROHS:</b>	Made by Order-Code

## Drawing

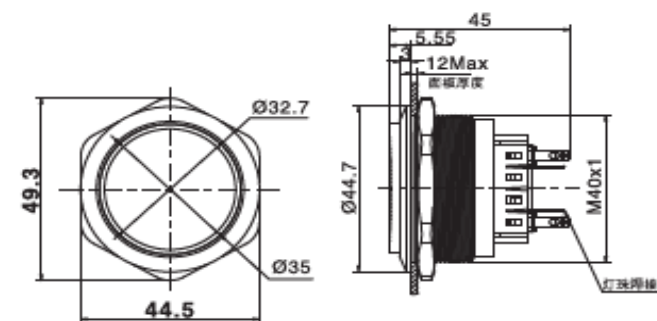

## 40MM Anti-Vandal-Switch

Part No.: **Q36094**

Customer:

DRW:	Jason	CHKD	Wilson	MATL:	Wilson	TOLERANCE	Mason	DATE	06.08.2017
APPD:	Schumi			FINISH	Jamy		Sheet No.	1 from 3	

# EDCON-COMPONENTS



## Visual Effect of Surface



Nickel - plated brass  
( Satin surface)



Stainless steel ( Spiral surface)



Gold - plated brass ( Satin surface)



G=Gray



B=Black



W=White

## Engraving Options

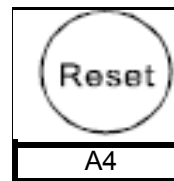

Order Code

A4

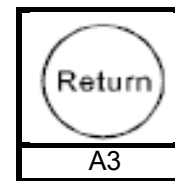

A3

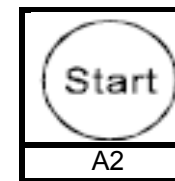

A2

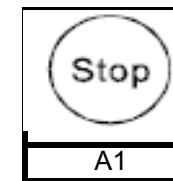

A1

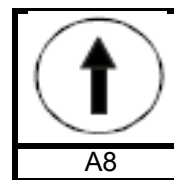

Order Code

A8

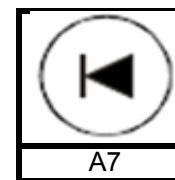

A7

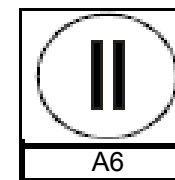

A6

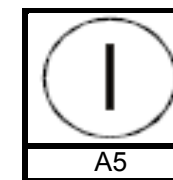

A5

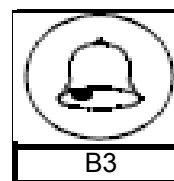

Order Code

B3

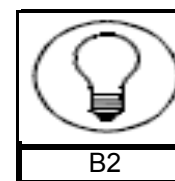

B2

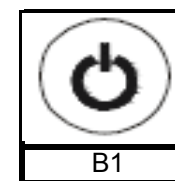

B1

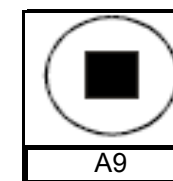

A9

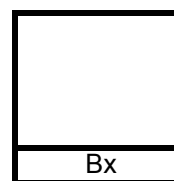

Order Code

Bx

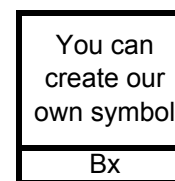

Bx

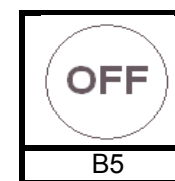

B5

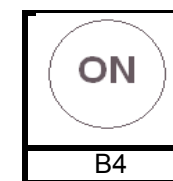

B4

**40MM Anti-Vandal-Switch**

Part No.: **Q36094**

DRW:	Jason	CHKD	Wilson	MATL:	Wilson	TOLERANCE	Mason	DATE	06.08.2017	Customer:
APPD:	Schumi			FINISH	Jamy		Sheet No.		2 from 3	

# EDCON-COMPONENTS



## Ordering Information

Serie	Front Shape	Contact Structure	Switch Function	Connect Type	Knob Color	Lamp Voltage	Crust Material	Engraving Options	ROHS	Packing Style
<b>Q36094</b>	<b>H</b>	<b>11</b>	<b>M</b>	<b>2</b>	<b>0</b>	<b>0</b>	<b>N</b>	<b>XX</b>	<b>R</b>	<b>N</b>

<b>H=</b> High		<b>M=</b> Momentary	<b>1=</b> Solder Lug 2,8x0,5mm	<b>0=</b> Same us Body	<b>0=</b> without	<b>S=</b> Stainless Steel	<b>XX=</b> w/o other Look Order Code Engraving Options	<b>R=</b> ROHS Conform	<b>N=</b> Carton
		<b>S=</b> Self Locking				<b>N=</b> Nickel Plated Brass			
	<b>11=</b> 1NO1NC								
	<b>22=</b> 2NO2NC								
	<b>33=</b> 3NO3NC								
	<b>44=</b> 4NO4NC								

<b>40MM Anti-Vandal-Switch</b>
Part No.: <b>Q36094</b>
Customer:

DRW:	Jason	CHKD	Wilson	MATL:	Wilson	TOLERANCE	Mason	DATE	06.08.2017
APPD:	Schumi			FINISH	Jamy		Sheet No.		3 from 3