

# EDCON-COMPONENTS



## Specifications

Voltage Range:	like order Code
Rated Current:	15mA
Type:	LED
Lifetime LED:	40000Hrs
The Crust Material	like order Code
IP Degree:	IP65 / IP67 / IK10
Color of LED	<b>R</b> <b>G</b> <b>Y</b> <b>O</b> <b>B</b> <b>W</b>
Max. Rev. Voltage:	5V
Terminal Style:	Pin Terminal ( 1,8x0,4mm)
Dielectric Strength:	1100VAC
Operating Temperature:	. -40°C ~ +85°C
Panel Thickness:	1 ~ 10mm
Torque:	5-14Nm
Viewing Angle:	100°

## Material

Lampshade:	PC
Body:	like Order Code
Base:	PBT
<b>ROHS:</b>	Made to Order-Code

## Drawing

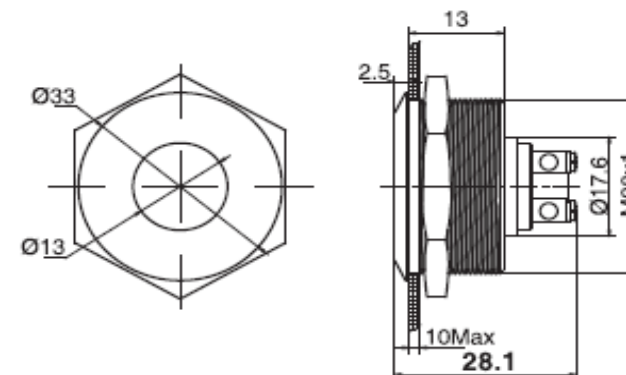

Luminous Intensity		
Lamp Colour	Standard Voltage	Smaller Voltage
Red	7500mcd	2000mcd
Green	4100mcd	250mcd
Yellow	2500mcd	350mcd
Blue	1300mcd	300mcd
White	1900mcd	200md

<b>28MM Anti-Vandal-INDICATOR</b>	
Part No.:	<b>Q35108</b>
Customer:	

DRW:	Jason	CHKD	Wilson	MATL:	Wilson	TOLERANCE	Mason	DATE	05.08.2017
APPD:	Schumi			FINISH	Jamy		Sheet No.		1 from 2

# EDCON-COMPONENTS



## Ordering Informations

Serie	Front Shape	Connect Type	Lamp Color	Lamp Voltage	Crust Material	ROHS	Packing Style
<b>Q35108</b>	<b>F</b>	<b>2</b>	<b>R</b>	<b>0</b>	<b>S</b>	<b>R</b>	<b>S</b>

			<b>0=</b> without Resistor before LED	<b>S=</b> Stainless Steel	<b>R=</b> ROHS Conform	<b>S=</b> Standard Packing
<b>F=</b> Flat	<b>2=</b> Screw Terminal	<b>R=</b> Red		<b>N=</b> Nickel Plated Brass	<b>N=</b> NON ROHS Conform	<b>I=</b> Individual Packing
		<b>G=</b> Green	<b>1=</b> 6V AC/DC	<b>G=</b> Gold Plated Brass		
		<b>Y=</b> Yellow	<b>2=</b> 12V AC/DC			
		<b>O=</b> Orange	<b>3=</b> 24V AC/DC			
		<b>B=</b> Blue	<b>4=</b> 36V AC/DC			
		<b>W=</b> White	<b>X=</b> can we make by order			

**28MM Anti-Vandal-INDICATOR**

Part No.: **Q35108**

DRW:	Jason	CHKD	Wilson	MATL:	Wilson	TOLERANCE	Mason	DATE	05.08.2017
APPD:	Schumi			FINISH	Jamy		Sheet No.		2 from 2

Customer: