

EDCON-COMPONENTS



Specifications

Voltage Range:	like order Code
Rated Current:	15mA
Type:	LED
Lifetime LED:	40000Hrs
The Crust Material	like order Code
IP Degree:	IP65 / IP67 / IK10
Color of LED	R G Y O B W
Max. Rev. Voltage:	5V
Terminal Style:	Pin Terminal (1,8x0,4mm)
Dielectric Strength:	1100VAC
Operating Temperature:	. -40°C ~ +85°C
Panel Thickness:	1 ~ 10mm
Torque:	5-14Nm
Viewing Angle:	100°

Material

Lampshade:	PC
Body:	like Order Code
Base:	PBT
ROHS:	Made to Order-Code

Drawing

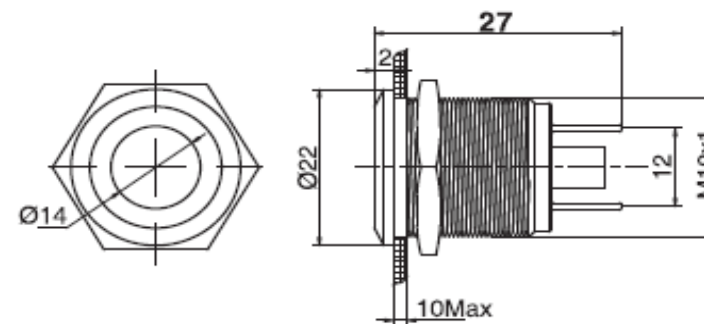

Luminous Intensity		
Lamp Colour	Standard Voltage	Smaller Voltage
Red	7500mcd	2000mcd
Green	4100mcd	250mcd
Yellow	2500mcd	350mcd
Blue	1300mcd	300mcd
White	1900mcd	200md

19MM Anti-Vandal-INDICATOR

Part No.: **Q35100**

DRW:	Jason	CHKD	Wilson	MATL:	Wilson	TOLERANCE	Mason	DATE	05.08.2017	Customer:
APPD:	Schumi			FINISH	Jamy		Sheet No.	1 from 2		

EDCON-COMPONENTS



Ordering Informations

Serie	Front Shape	Connect Type	Lamp Color	Lamp Voltage	Crust Material	ROHS	Packing Style
Q35100	F	1	R	0	S	R	S

	1= Solder Lug		0= without Resistor before LED	S= Stainless Steel	R= ROHS Conform	S= Standard Packing
F= Flat		R= Red		N= Nickel Plated Brass	N= NON ROHS Conform	I= Individual Packing
		G= Green	1= 6V AC/DC	G= Gold Plated Brass		
		Y= Yellow	2= 12V AC/DC			
		O= Orange	3= 24V AC/DC			
		B= Blue	4= 36V AC/DC			
		W= White	X= can we make by order			

19MM Anti-Vandal-INDICATOR

Part No.: **Q35100**

DRW:	Jason	CHKD	Wilson	MATL:	Wilson	TOLERANCE	Mason	DATE	05.08.2017
APPD:	Schumi			FINISH	Jamy		Sheet No.		2 from 2

Customer: