

# EDCON-COMPONENTS



## Specifications

Switch Rating: 24V/2A  
 Contact Configuration: 1NO  
  
 IP-Degree: IP65  
 Crust Material: Look order Code  
 Terminal Type: Look order Code  
 Switching: Momentary  
 Contact Resistance:  $\leq 50\text{m}\Omega$   
 Insulation Resistance:  $\geq 1000\text{M}\Omega$   
 Dielectric Strength: 2000VAC  
 Operating Temperature:  $-20^{\circ}\text{C} \sim +55^{\circ}\text{C}$   
 Mechanical Life: 500.000 cycles  
 Electrical Life: 50.000 cycles  
 Panel Thickness: 1 ~ 10mm  
 Nut Torque: 5 ~ 14Nm  
 Operating Pressure: About 5N

## Drawing

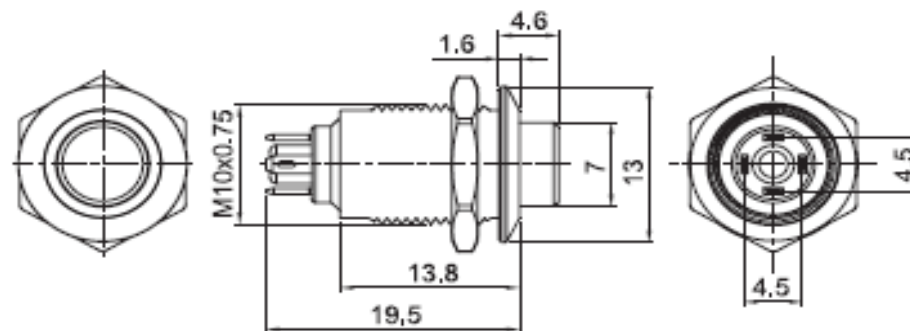

Operating Stroke: About 1,5mm

## Material

Contact: Silver Alloy  
 Button: Look order Code  
 Body: Look order Code  
 Base: PA66  
**ROHS:** Made by Order-Code

**10MM Anti-Vandal-Switch**

Part No.: **Q36120-**

DRW:	Jason	CHKD	Wilson	MATL:	Wilson	TOLERANCE	Mason	DATE	18.06.2019
APPD:	Schumi			FINISH	Jamy		Sheet No.		1 from 3

Customer:

[www.edcon-components.com](http://www.edcon-components.com)

email: [info@edcon-components.com](mailto:info@edcon-components.com)

# EDCON-COMPONENTS



## Visual Effect of Surface



Nickel - plated brass  
(Satin surface)



Stainless steel (Spiral surface)



Gold - plated brass (Satin surface)



G=Gray



B=Black



W=White

## Engraving Options

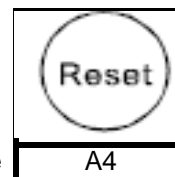

Order Code

A4

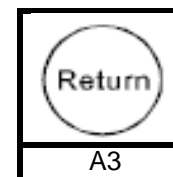

A3

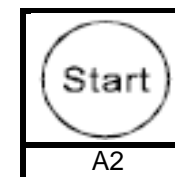

A2

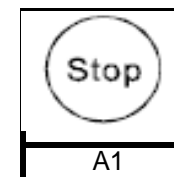

A1

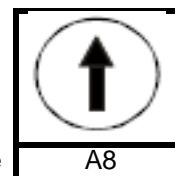

Order Code

A8

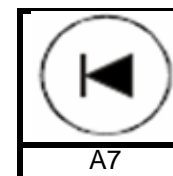

A7

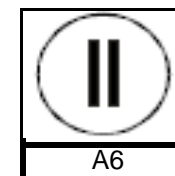

A6

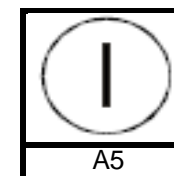

A5

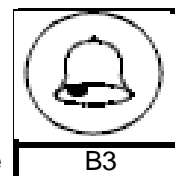

Order Code

B3

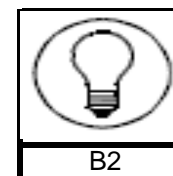

B2

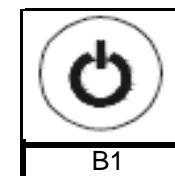

B1

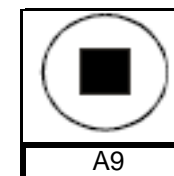

A9

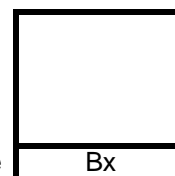

Order Code

Bx

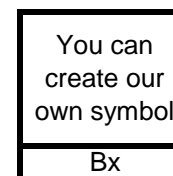

Bx

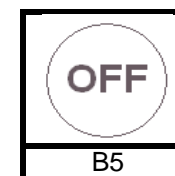

B5

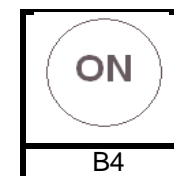

B4

**10MM Anti-Vandal-Switch**

Part No.: **Q36120-**

Customer:

DRW:	Jason	CHKD	Wilson	MATL:	Wilson	TOLERANCE	Mason	DATE	18.06.2019
APPD:	Schumi			FINISH	Jamy		Sheet No.	2 from 3	

# EDCON-COMPONENTS



## Ordering Information

Serie	Front Shape	Contact Structure	Lamp Type	Connect Type	Knob Color	Lamp Voltage	Crust Material	Engraving Options	ROHS	Packing Style
<b>Q36120-</b>	<b>H</b>	<b>10</b>	<b>N</b>	<b>1</b>	<b>Y</b>	<b>0</b>	<b>N</b>	<b>XX</b>	<b>R</b>	<b>N</b>

<b>H= High</b>	<b>10= 1NO</b>	<b>N= no Function</b>	<b>1= Solder Lug</b>	<b>A= Same us Body</b>	<b>0= without</b>	<b>S= Stainless Steel</b>	<b>XX= w/o other Look Order Code Engraving Options</b>	<b>R= ROHS Conform</b>	<b>N= White Carton</b>
						<b>N= Nickel Plated Brass</b>			
					<b>G= Gold Plated Brass</b>				

<b>10MM Anti-Vandal-Switch</b>
Part No.: <b>Q36120-</b>
Customer:

DRW:	Jason	CHKD	Wilson	MATL:	Wilson	TOLERANCE	Mason	DATE	18.06.2019
APPD:	Schumi			FINISH	Jamy		Sheet No.		3 from 3

