

EDCON-COMPONENTS



Specifications

| | |
|------------------------|-----------------|
| Switch Rating: | 5A/250VAC |
| Contact Configuration: | 1NO |
| IP-Degree: | IP65 / IK08 |
| Crust Material: | Look order Code |
| Terminal Type: | Look order Code |
| Switching: | Momentary |
| Contact Resistance: | ≤ 50mΩ |
| Insulation Resistance: | ≥ 1000MΩ |
| Dielectric Strength: | 2000VAC |
| Operating Temperature: | -20°C ~ +55°C |
| Mechanical Life: | 500.000 cycles |
| Electrical Life: | 50.000 cycles |
| Panel Thickness: | 1 ~ 10mm |
| Nut Torque: | 5 ~ 14Nm |
| Operating Pressure: | About 3~5Nm |
| Operating Stroke: | About 2,5mm |

Drawing

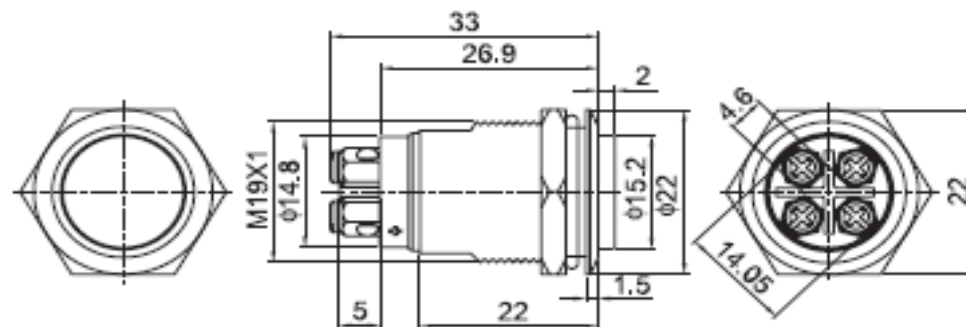

Material

| | |
|--------------|--------------------|
| Contact: | Silver Alloy |
| Button: | Look order Code |
| Body: | Look order Code |
| Base: | PA66 |
| ROHS: | Made by Order-Code |

19MM Anti-Vandal-Switch

Part No.: **Q36111-**

| | | | | | | | | | |
|-------|--------|------|--------|--------|--------|-----------|-----------|------|------------|
| DRW: | Jason | CHKD | Wilson | MATL: | Wilson | TOLERANCE | Mason | DATE | 13.06.2019 |
| APPD: | Schumi | | | FINISH | Jamy | | Sheet No. | | 1 from 3 |

Customer:

www.edcon-components.com

email: info@edcon-components.com

EDCON-COMPONENTS



Visual Effect of Surface



Nickel - plated brass
(Satin surface)



Stainless steel (Spiral surface)



Gold - plated brass (Satin surface)



G=Gray



B=Black



W=White

Engraving Options

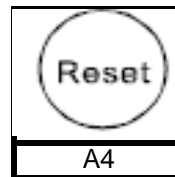

Order Code

A4

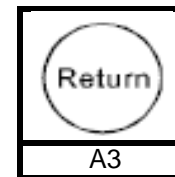

A3

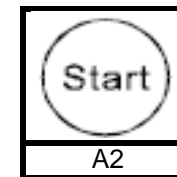

A2

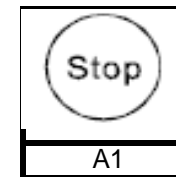

A1

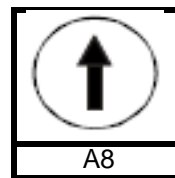

Order Code

A8

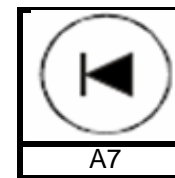

A7

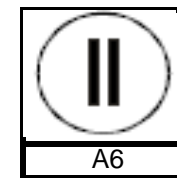

A6

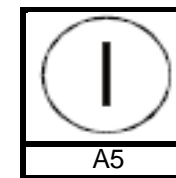

A5

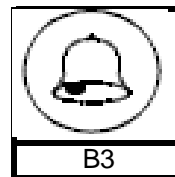

Order Code

B3

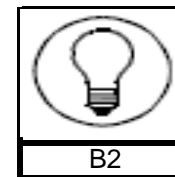

B2

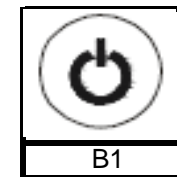

B1

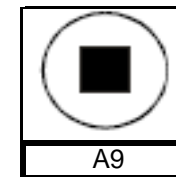

A9

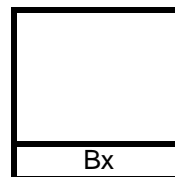

Order Code

Bx

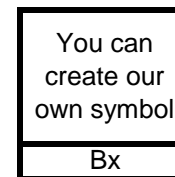

Bx

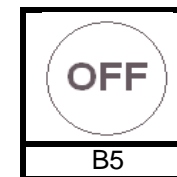

B5

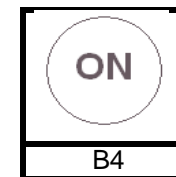

B4

19MM Anti-Vandal-Switch

Part No.: **Q36111-**

| | | | | | | | | | |
|-------|--------|------|--------|--------|--------|-----------|-----------|----------|------------|
| DRW: | Jason | CHKD | Wilson | MATL: | Wilson | TOLERANCE | Mason | DATE | 13.06.2019 |
| APPD: | Schumi | | | FINISH | Jamy | | Sheet No. | 2 from 3 | Customer: |

EDCON-COMPONENTS



Ordering Information

| Serie | Front Shape | Contact Structure | Lamp Type | Connect Type | Knob Color | Lamp Voltage | Crust Material | Engraving Options | ROHS | Packing Style |
|----------------|-------------|-------------------|-----------|--------------|------------|--------------|----------------|-------------------|----------|---------------|
| Q36111- | H | 22 | N | 2 | A | 0 | N | XX | R | N |

| | | | | | | | | | |
|----------------|----------------|-----------------------|--------------------------|------------------------|-------------------|-------------------------------|--|------------------------|------------------------|
| H= High | 10= 1NO | N= no Function | | A= Same us Body | 0= without | S= Stainless Steel | XX= w/o other Look Order Code Engraving Options | R= ROHS Conform | N= White Carton |
| | | | 2= Screw Terminal | | | N= Nickel Plated Brass | | | |
| | | | | | | G= Gold Plated Brass | | | |
| | | | | | | | | | |
| | | | | | | | | | |
| | | | | | | | | | |
| | | | | | | | | | |

| | |
|--------------------------------|----------------|
| 19MM Anti-Vandal-Switch | |
| Part No.: | Q36111- |
| Customer: | |

| | | | | | | | | | |
|-------|--------|------|--------|--------|--------|-----------|-----------|------|------------|
| DRW: | Jason | CHKD | Wilson | MATL: | Wilson | TOLERANCE | Mason | DATE | 13.06.2019 |
| APPD: | Schumi | | | FINISH | Jamy | | Sheet No. | | 3 from 3 |