

EDCON-COMPONENTS



Specifications

| | |
|------------------------|------------------------|
| Switch Rating: | ≤2A / 36VDC |
| Contact Configuration: | 1NO |
| Operating Type: | Self-Locking |
| IP-Degree: | IP67 |
| Crust Material: | look by order |
| Terminal Type: | Solder Lug (2,8x0,5mm) |
| Switching: | Self-Locking |
| Contact Resistance: | ≤ 50mΩ |
| Insulation Resistance: | ≥ 1000MΩ |
| Dielectric Strength: | 2000VAC 1Min. |
| Operating Temperature: | . -20°C ~ +55°C |
| Mechanical Life: | 500.000 cycles |
| Electrical Life: | 50.000 cycles |
| Panel Thickness: | 1 ~ 6mm |
| Torque: | 5 ~ 14Nm |
| Operating Pressure: | About 3~6N |
| Operating Distance: | About 2,5Nm |

Material

| | | | | | | | |
|----------------|--|----------|----------|----------|----------|----------|----------|
| Contact: | Silver Alloy | | | | | | |
| Button: | Made by Order | | | | | | |
| Body: | | | | | | | |
| Base: | PBT | | | | | | |
| ROHS: | Made to Order-Code | | | | | | |
| Type: | Illuminated (LED) | | | | | | |
| Color: | <table border="0"> <tr> <td>R</td> <td>Y</td> <td>O</td> <td>G</td> <td>B</td> <td>W</td> </tr> </table> | R | Y | O | G | B | W |
| R | Y | O | G | B | W | | |
| Rated Voltage: | AC/DC 6V AC/DC 12V | | | | | | |
| Rated Current: | 15mA | | | | | | |
| Lifetime: | 40000Hrs | | | | | | |

Drawing

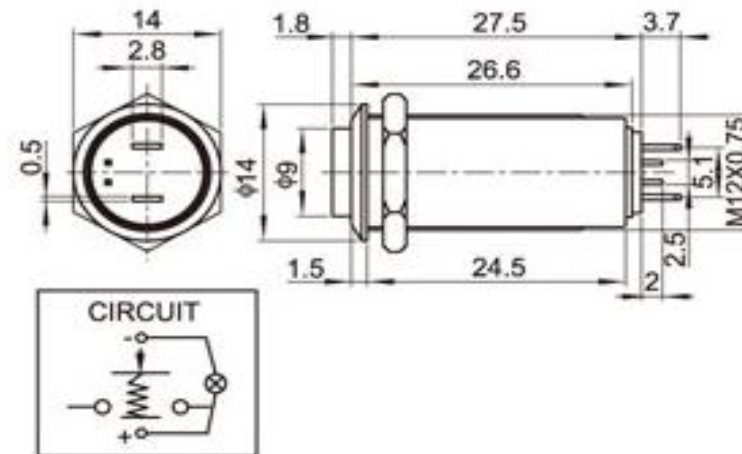

Current Limiting Resistance Configuration Table

| Operating Voltage (U) | 6V | 12V | 24V | 36V |
|----------------------------|------------|------------|-------------|-------------|
| R Y O | 210Ω, 1/4W | 510Ω, 1/4W | 1,2KΩ, 1/4W | 2,2KΩ, 1/4W |
| G B W | 160Ω, 1/4W | 470Ω, 1/4W | 1,2KΩ, 1/4W | 2,2KΩ, 1/4W |

| | |
|---------|-----------------------|
| Formula | |
| R= | $\frac{U - U_e}{I_e}$ |

12MM Anti-Vandal-Switch

Part No.: **Q35075**

| | | | | | | | | | | |
|-------|--------|------|--------|--------|--------|-----------|-----------|----------|------------|-----------|
| DRW: | Jason | CHKD | Wilson | MATL: | Wilson | TOLERANCE | Mason | DATE | 06.06.2019 | Customer: |
| APPD: | Schumi | | | FINISH | Jamy | | Sheet No. | 1 from 3 | | |

EDCON-COMPONENTS



Visual Effect of Surface



Nickel - plated brass
(Satin surface)



Stainless steel (Spiral surface)

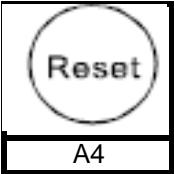
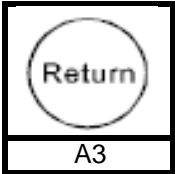
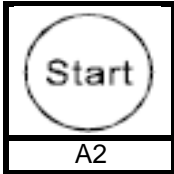
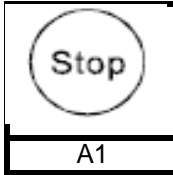
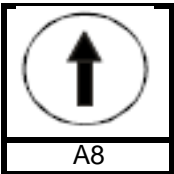
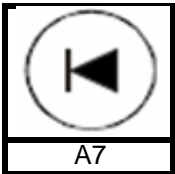
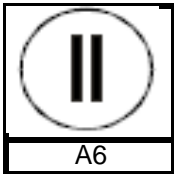
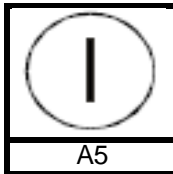
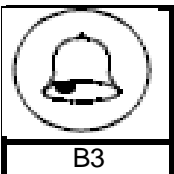
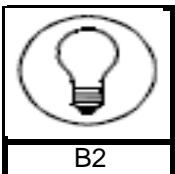
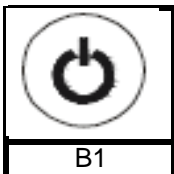
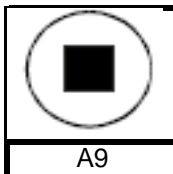
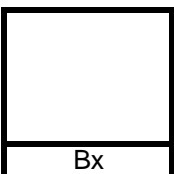
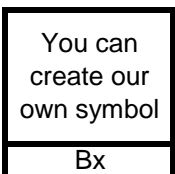
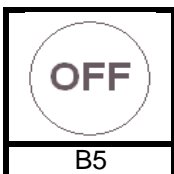
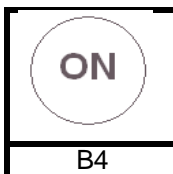

Gold - plated brass (Satin surface)

| | | | | |
|------------|---|--|---|---|
| Order Code |  A4 |  A3 |  A2 |  A1 |
| Order Code |  A8 |  A7 |  A6 |  A5 |
| Order Code |  B3 |  B2 |  B1 |  A9 |
| Order Code |  Bx |  Bx You can create our own symbol |  B5 |  B4 |

12MM Anti-Vandal-Switch

Part No.: **Q35075**

| | | | | | | | | | |
|-------|--------|------|--------|--------|--------|-----------|-----------|----------|------------|
| DRW: | Jason | CHKD | Wilson | MATL: | Wilson | TOLERANCE | Mason | DATE | 06.06.2019 |
| APPD: | Schumi | | | FINISH | Jamy | | Sheet No. | 2 from 3 | Customer: |

EDCON-COMPONENTS



Ordering Informations

| Serie | Front Shape | Contact Structure | Lamp Type | Connect Type | Lamp Color | Lamp Voltage | Crust Material | Engraving Options | ROHS | Packing Style |
|---------------|-------------|-------------------|-----------|--------------|------------|--------------|----------------|-------------------|----------|---------------|
| Q35075 | H | 10 | R | 1 | A | 0 | S | 00 | R | N |

| | | | | | | | | | |
|----------------|--|---------------------|-----------------------------|-----------------------|---------------------------------------|-------------------------------|------------------------|----------------------------|------------------------------|
| | | R= RING-Size | | A= No Function | 0= with 0R Resistor before LED | S= Stainless Steel | 00= No function | R= ROHS Conform | N= White Carton |
| H= High | | | | R= Red | | N= Nickel Plated Brass | | N= NON ROHS Conform | I= Individual Packing |
| | | | 1= Solder Lug | G= Green | 1= 6V AC/DC | G= Gold Plated Brass | | | |
| | | | | Y= Yellow | 2= 12V AC/DC | | | | |
| | | | | O= Orange | 3= 24V AC/DC | | | | |
| | | | | B= Blue | 4= 36V AC/DC | | | | |
| | | | | W= White | X= can we make by order | | | | |
| | | | | | | | | | |
| | | | | | | | | | |
| | | | 10= 1NO Self-Locking | | | | | | |

12MM Anti-Vandal-Switch
Part No.: **Q35075**

| | | | | | | | | | | |
|-------|--------|------|--------|--------|--------|-----------|-----------|----------|------------|-----------|
| DRW: | Jason | CHKD | Wilson | MATL: | Wilson | TOLERANCE | Mason | DATE | 06.06.2019 | Customer: |
| APPD: | Schumi | | | FINISH | Jamy | | Sheet No. | 3 from 3 | | |

www.edcon-components.com

email: info@edcon-components.com