

EDCON-COMPONENTS



Specifications

Switch Rating:	≤2A / 36VDC
Contact Configuration:	1NO
Operating Type:	Self-Locking
IP-Degree:	IP67
Crust Material:	look by order
Terminal Type:	Solder Lug (2,8x0,5mm)
Switching:	ON (Self-Locking)
Contact Resistance:	≤ 50mΩ
Insulation Resistance:	≥ 1000MΩ
Dielectric Strength:	2000VAC 1Min.
Operating Temperature:	. -20°C ~ +55°C
Mechanical Life:	500.000 cycles
Electrical Life:	50.000 cycles
Panel Thickness:	1 ~ 10mm
Torque:	5 ~ 14Nm
Operating Pressure:	About 3~6N
Operating Distance:	About 2,5Nm

Material

Contact:	Silver Alloy						
Button:	Made by Order						
Body:	PBT						
Base:	Made to Order-Code						
ROHS:	Illuminated (LED)						
Type:							
Color:	<table border="0"> <tr> <td>R</td> <td>Y</td> <td>O</td> <td>G</td> <td>B</td> <td>W</td> </tr> </table>	R	Y	O	G	B	W
R	Y	O	G	B	W		
Rated Voltage:	AC/DC 6V AC/DC 12V						
Rated Current:	15mA						
Lifetime:	40000Hrs						

Drawing

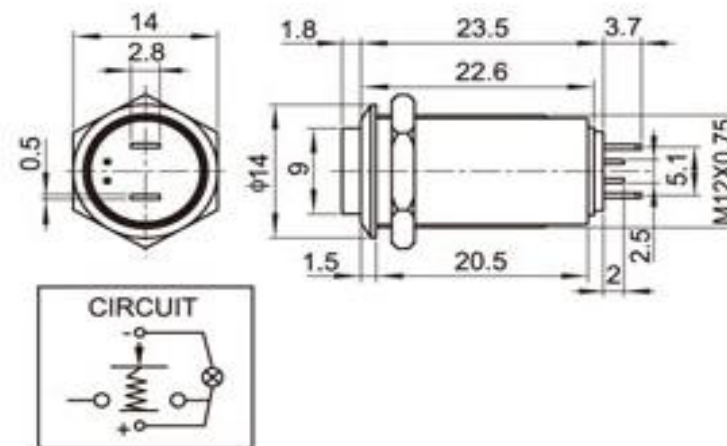

Current Limiting Resistance Configuration Table

Operating Voltage (U)	6V	12V	24V	36V
R Y O	210Ω, 1/4W	510Ω, 1/4W	1,2KΩ, 1/4W	2,2KΩ, 1/4W
G B W	160Ω, 1/4W	470Ω, 1/4W	1,2KΩ, 1/4W	2,2KΩ, 1/4W

Formula	
R=	$\frac{U - U_e}{I_e}$

12MM Anti-Vandal-Switch

Part No.: **Q35069**

DRW:	Jason	CHKD:	Wilson	MATL:	Wilson	TOLERANCE:	Mason	DATE:	05.06.2019
APPD:	Schumi	FINISH:	Jamy	Sheet No.:	1 from 3		Customer:		

EDCON-COMPONENTS



Visual Effect of Surface



Nickel - plated brass
(Satin surface)



Stainless steel (Spiral surface)

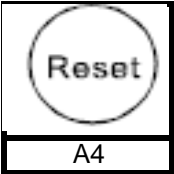
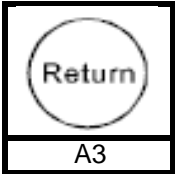
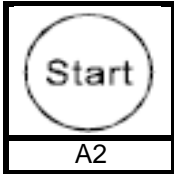
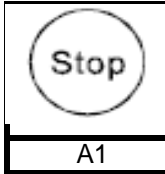
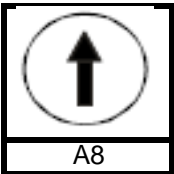
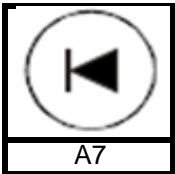
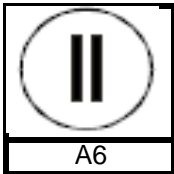
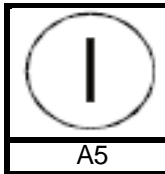
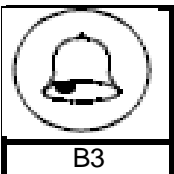
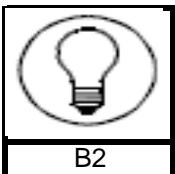
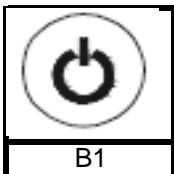
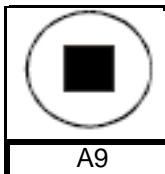
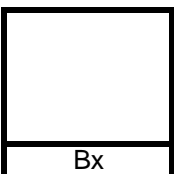
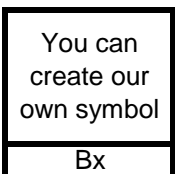
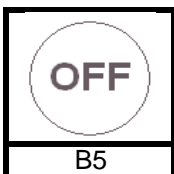
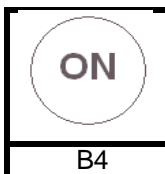

Gold - plated brass (Satin surface)

Order Code	 A4	 A3	 A2	 A1
Order Code	 A8	 A7	 A6	 A5
Order Code	 B3	 B2	 B1	 A9
Order Code	 Bx	 Bx You can create our own symbol	 B5	 B4

12MM Anti-Vandal-Switch

Part No.: **Q35069**

Customer:

DRW:	Jason	CHKD	Wilson	MATL:	Wilson	TOLERANCE	Mason	DATE	05.06.2019
APPD:	Schumi			FINISH	Jamy		Sheet No.	2 from 3	

EDCON-COMPONENTS



Ordering Informations

Serie	Front Shape	Contact Structure	Lamp Type	Connect Type	Lamp Color	Lamp Voltage	Crust Material	Engraving Options	ROHS	Packing Style
Q35069	F	10	D	3	A	0	S	00	R	N

		D= DOT-Size		A= No Function	0= with 0R Resistor before LED	S= Stainless Steel	00= No function	R= ROHS Conform	N= White Carton
H= High				R= Red		N= Nickel Plated Brass		N= NON ROHS Conform	I= Individual Packing
			1= Solder Lug	G= Green	1= 6V AC/DC	G= Gold Plated Brass			
				Y= Yellow	2= 12V AC/DC				
				O= Orange	3= 24V AC/DC				
				B= Blue	4= 36V AC/DC				
		10=1NO (Self-Locking)		W= White	X= can we make by order				

12MM Anti-Vandal-Switch
Part No.: **Q35069**

DRW:	Jason	CHKD	Wilson	MATL:	Wilson	TOLERANCE	Mason	DATE	05.06.2019	Customer:
APPD:	Schumi			FINISH	Jamy		Sheet No.	3 from 3		