

EDCON-COMPONENTS

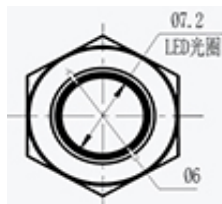

Specifications

Switch Rating:	≤2A / 3~250VAC/DC
Contact Configuration:	1NO/NC
Operating Type:	Momentary
IP-Degree:	IP67
Crust Material:	look by order
Terminal Type:	Solder Lug (2,8x0,5mm)
Switching:	ON (Momentary)
Contact Resistance:	≤ 50mΩ
Insulation Resistance:	≥ 100MΩ
Dielectric Strength:	2000VAC 1Min.
Operating Temperature:	..-25°C ~ +55°C
Mechanical Life:	1.000.000 cycles
Electrical Life:	10.000 cycles
Panel Thickness:	1 ~ 10mm
Torque:	5 ~ 14Nm
Operating Pressure:	About 3~6N
Operating Distance:	About 2,5Nm

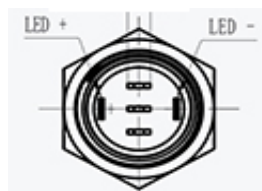
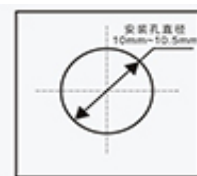

Drawing

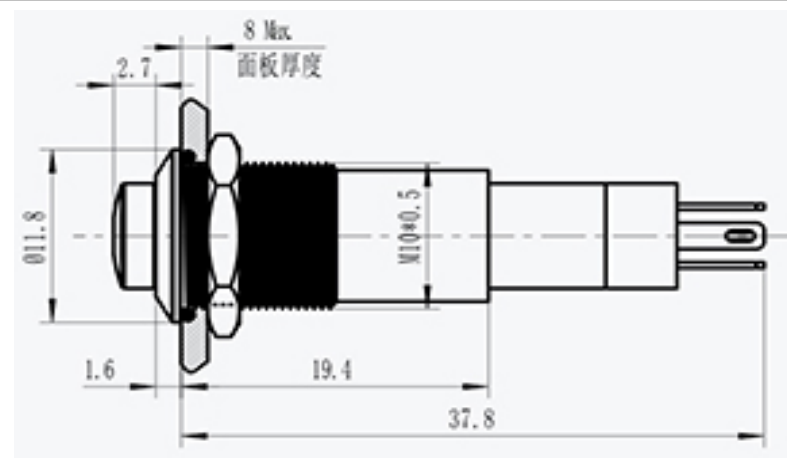

Material

Contact:	Silver Alloy
Button:	Made by Order
Body:	PBT
Base:	Made to Order-Code
ROHS:	Illuminated (LED)
Type:	
Color:	R Y O G B W
Rated Voltage:	AC/DC 1,7V AC/DC 2,8V
Rated Current:	20mA
Lifetime:	40000Hrs

Chematic



Connecting

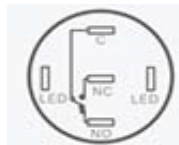

Current Limiting Resistance Configuration Table

Operating Voltage (U)	6V	12V	24V	36V
R Y O	210Ω, 1/4W	510Ω, 1/4W	1,2KΩ, 1/4W	2,2KΩ, 1/4W
G B W	160Ω, 1/4W	470Ω, 1/4W	1,2KΩ, 1/4W	2,2KΩ, 1/4W

Formula	
R=	$\frac{U - U_e}{I_e}$

10MM Anti-Vandal-Switch

Part No.: **Q35061**

DRW:	Jason	CHKD	Wilson	MATL:	Wilson	TOLERANCE	Mason	DATE	05.03.2017	Customer:
APPD:	Schumi			FINISH	Jamy		Sheet No.	1 from 3		

EDCON-COMPONENTS



Visual Effect of Surface

















Nickel - plated brass
(Satin surface)



Stainless steel (Spiral surface)



Gold - plated brass (Satin surface)

Order Code	 A4	 A3	 A2	 A1
Order Code	 A8	 A7	 A6	 A5
Order Code	 B3	 B2	 B1	 A9
Order Code	 Bx	You can create our own symbol Bx	 B5	 B4

10MM Anti-Vandal-Switch	
Part No.:	Q35061
Customer:	

DRW:	Jason	CHKD	Wilson	MATL:	Wilson	TOLERANCE	Mason	DATE	05.03.2017
APPD:	Schumi			FINISH	Jamy		Sheet No.		2 from 3

EDCON-COMPONENTS



Ordering Informations

Serie	Front Shape	Contact Structure	Lamp Type	Connect Type	Lamp Color	Lamp Voltage	Crust Material	Engraving Options	ROHS	Packing Style
Q35061	H	11	R	3	A	0	S	00	R	N

H= High	11= 1NO1NC Momentary	R= RING-Size	3= Pin Terminal	A= No Function	0= with 0R Resistor before LED	S= Stainless Steel	00= No function	R= ROHS Conform	N= White Carton
				R= Red		N= Nickel Plated Brass		N= NON ROHS Conform	I= Individual Packing
				G= Green	1= 6V AC/DC	G= Gold Plated Brass			
				Y= Yellow	2= 12V AC/DC				
				O= Orange	3= 24V AC/DC				
				B= Blue	4= 36V AC/DC				
				W= White	X= can we make by order				

10MM Anti-Vandal-Switch

Part No.: **Q35061**

DRW:	Jason	CHKD	Wilson	MATL:	Wilson	TOLERANCE	Mason	DATE	05.03.2017	Customer:
APPD:	Schumi			FINISH	Jamy		Sheet No.	3 from 3		