

EDCON-COMPONENTS



Specifications

Switch Rating:	5A/250VAC
Contact Configuration:	1NO/NC / 2NO/NC
IP-Degree:	IP67 / IK10
Crust Material:	Look order Code
Terminal Type:	Look order Code
Switching:	Momentary / Self-Locking
Contact Resistance:	≤ 50mΩ
Insulation Resistance:	≥ 1000MΩ
Dielectric Strength:	2000VAC
Operating Temperature:	-20°C ~ +55°C
Mechanical Life:	500.000 cycles
Electrical Life:	50.000 cycles
Panel Thickness:	1 ~ 10mm
Nut Torque:	5 ~ 14Nm
Operating Pressure:	About 3-5Nm

Operating Stroke: About 2,5mm

Material

Contact:	Silver Alloy
Button:	Look order Code
Body:	Look order Code
Base:	PA66
ROHS:	Made by Order-Code

Drawing

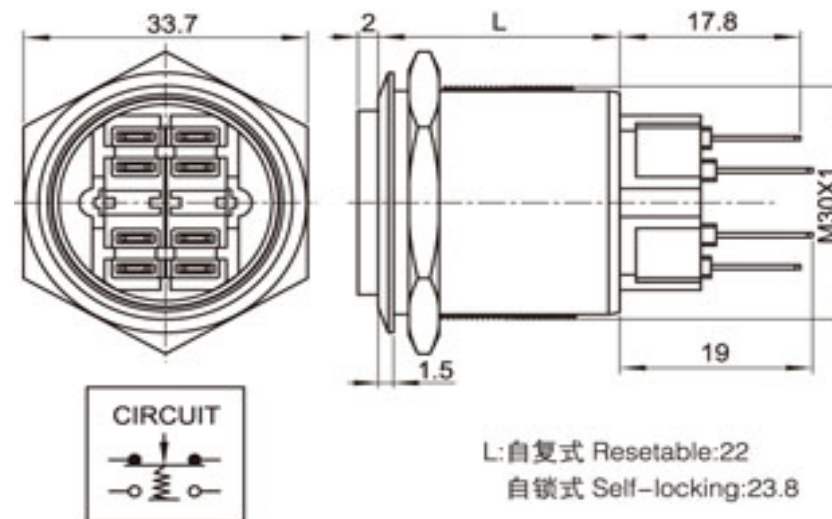

30MM Anti-Vandal-Switch

Part No.: **Q36092-**

Customer:

DRW:	Jason	CHKD	Wilson	MATL:	Wilson	TOLERANCE	Mason	DATE	18.06.2017
APPD:	Schumi			FINISH	Jamy		Sheet No.		1 from 3

www.edcon-components.com

email: info@edcon-components.com

EDCON-COMPONENTS



Visual Effect of Surface



Nickel - plated brass
(Satin surface)



Stainless steel (Spiral surface)



Gold - plated brass (Satin surface)



G=Gray



B=Black



W=White

Engraving Options

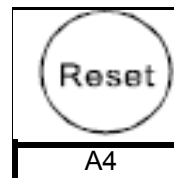

Order Code

A4

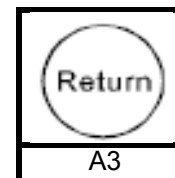

Order Code

A3

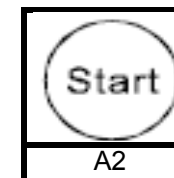

Order Code

A2

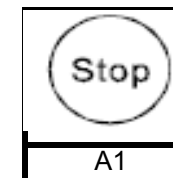

Order Code

A1

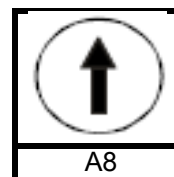

Order Code

A8

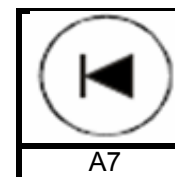

Order Code

A7

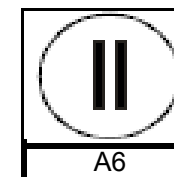

Order Code

A6

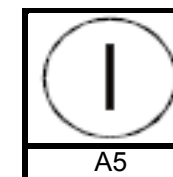

Order Code

A5

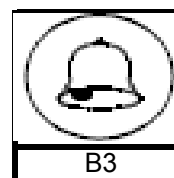

Order Code

B3

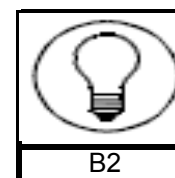

Order Code

B2

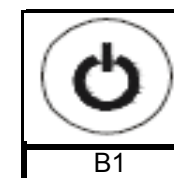

Order Code

B1

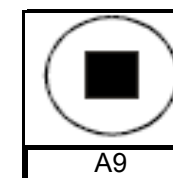

Order Code

A9

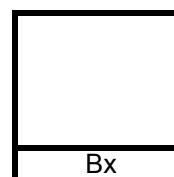

Order Code

Bx

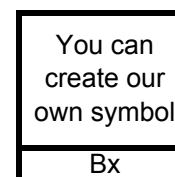

You can create our own symbol

Order Code

Bx

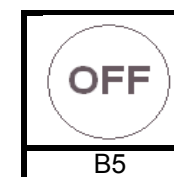

OFF

Order Code

B5

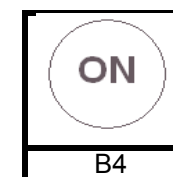

ON

Order Code

B4

30MM Anti-Vandal-Switch

Part No.: **Q36092-**

DRW:	Jason	CHKD	Wilson	MATL:	Wilson	TOLERANCE	Mason	DATE	18.06.2017	Customer:
APPD:	Schumi			FINISH	Jamy		Sheet No.		2 from 3	

EDCON-COMPONENTS



Ordering Information

Serie	Front Shape	Contact Structure	Lamp Type	Connect Type	Knob Color	Lamp Voltage	Crust Material	Engraving Options	ROHS	Packing Style
Q36092-	H	11	N	1	Y	0	N	XX	R	N

H= High		N= no Function	1= Solder Lug 2,8x0,5mm	A= Same us Body	0= without	S= Stainless Steel	XX= w/o other Look Order Code Engraving Options	R= ROHS Conform	N= White Carton
						N= Nickel Plated Brass			
	11= 1NO/NC							N= NON ROHS Conform	I= Individual Packing
	22= 2NO/NC					G= Gold Plated Brass			
	44= 1NO/NC Self-Locking								
	55= 2NO/NC Self-Locking								

30MM Anti-Vandal-Switch	
Part No.:	Q36092-
Customer:	

DRW:	Jason	CHKD	Wilson	MATL:	Wilson	TOLERANCE	Mason	DATE	18.06.2017
APPD:	Schumi			FINISH	Jamy		Sheet No.		3 from 3