

EDCON-COMPONENTS



Specifications

Switch Rating: 5A/250VAC
 Contact Configuration: 1NO/NC / 2NO/NC

 IP-Degree: IP67 / IK10
 Crust Material: Look order Code
 Terminal Type: Look order Code
 Switching: Momentary / Self-Locking
 Contact Resistance: $\leq 50\text{m}\Omega$
 Insulation Resistance: $\geq 1000\text{M}\Omega$
 Dielectric Strength: 2000VAC
 Operating Temperature: $-20^{\circ}\text{C} \sim +55^{\circ}\text{C}$
 Mechanical Life: 500.000 cycles
 Electrical Life: 50.000 cycles
 Panel Thickness: 1 ~ 10mm
 Nut Torque: 5 ~ 14Nm
 Operating Pressure: About 3-5Nm

Operating Stroke: About 2,5mm

Material

Contact: Silver Alloy
 Button: Look order Code
 Body: Look order Code
 Base: PA66
ROHS: Made by Order-Code

Drawing

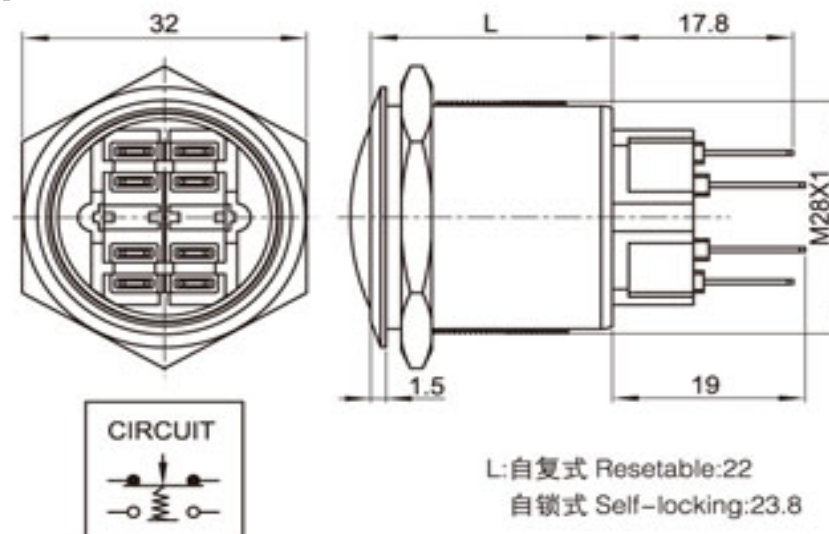

28MM Anti-Vandal-Switch

Part No.: **Q36088-**

Customer:

DRW:	Jason	CHKD	Wilson	MATL:	Wilson	TOLERANCE	Mason	DATE	18.06.2017
APPD:	Schumi			FINISH	Jamy		Sheet No.	1 from 3	

EDCON-COMPONENTS



Visual Effect of Surface



Nickel - plated brass
(Satin surface)



Stainless steel (Spiral surface)



Gold - plated brass (Satin surface)

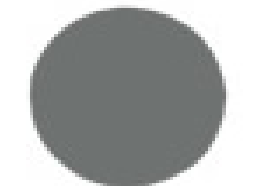

G=Gray



B=Black



W=White

Engraving Options

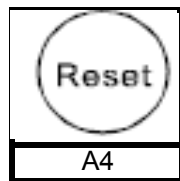

Order Code A4

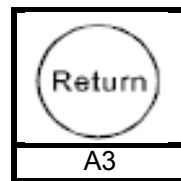

Order Code A3

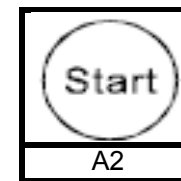

Order Code A2

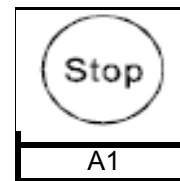

Order Code A1

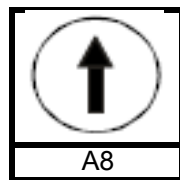

Order Code A8

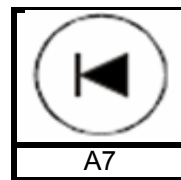

Order Code A7

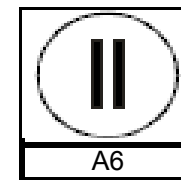

Order Code A6

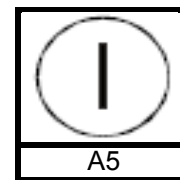

Order Code A5

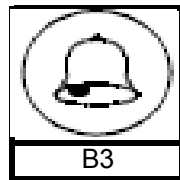

Order Code B3

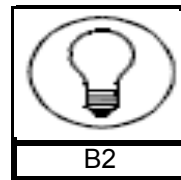

Order Code B2

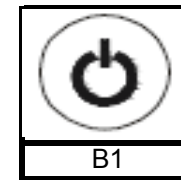

Order Code B1

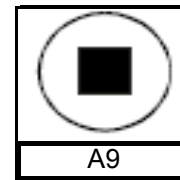

Order Code A9

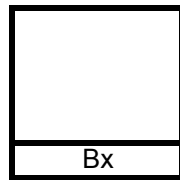

Order Code Bx

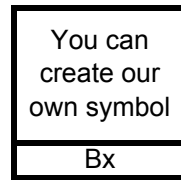

Order Code Bx

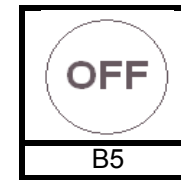

Order Code B5

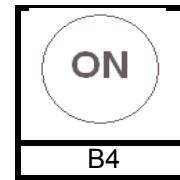

Order Code B4

28MM Anti-Vandal-Switch	
Part No.:	Q36088-
Customer:	

DRW:	Jason	CHKD	Wilson	MATL:	Wilson	TOLERANCE	Mason	DATE	18.06.2017
APPD:	Schumi			FINISH	Jamy		Sheet No.		2 from 3

EDCON-COMPONENTS



Ordering Information

Serie	Front Shape	Contact Structure	Lamp Type	Connect Type	Knob Color	Lamp Voltage	Crust Material	Engraving Options	ROHS	Packing Style
Q36088-	B	11	N	1	Y	0	N	XX	R	N

		N= no Function	1= Solder Lug 2,8x0,5mm	A= Same us Body	0= without	S= Stainless Steel	XX= w/o other Look Order Code Engraving Options	R= ROHS Conform	N= White Carton
B= Domed						N= Nickel Plated Brass		N= NON ROHS Conform	I= Individual Packing
	11= 1NO/NC								
	22= 2NO/NC					G= Gold Plated Brass			
	44= 1NO/NC Self-Locking								
	55= 2NO/NC Self-Locking								

28MM Anti-Vandal-Switch	
Part No.:	Q36088-
Customer:	

DRW:	Jason	CHKD	Wilson	MATL:	Wilson	TOLERANCE	Mason	DATE	18.06.2017
APPD:	Schumi			FINISH	Jamy		Sheet No.	3 from 3	