

EDCON-COMPONENTS



Specifications

Switch Rating: 5A/250VAC
 Contact Configuration: 1NO/NC / 2NO/NC

IP-Degree: IP67 / IK10
 Crust Material: Look order Code
 Terminal Type: Look order Code
 Switching: Momentary / Self-Locking
 Contact Resistance: $\leq 50\text{m}\Omega$
 Insulation Resistance: $\geq 1000\text{M}\Omega$
 Dielectric Strength: 2000VAC
 Operating Temperature: $-20^{\circ}\text{C} \sim +55^{\circ}\text{C}$
 Mechanical Life: 500.000 cycles
 Electrical Life: 50.000 cycles
 Panel Thickness: 1 ~ 10mm
 Nut Torque: 5 ~ 14Nm
 Operating Pressure: About 3-5Nm

Operating Stroke: About 2,5mm

Material

Contact: Silver Alloy
 Button: Look order Code
 Body: Look order Code
 Base: PA66
ROHS: Made by Order-Code

Drawing

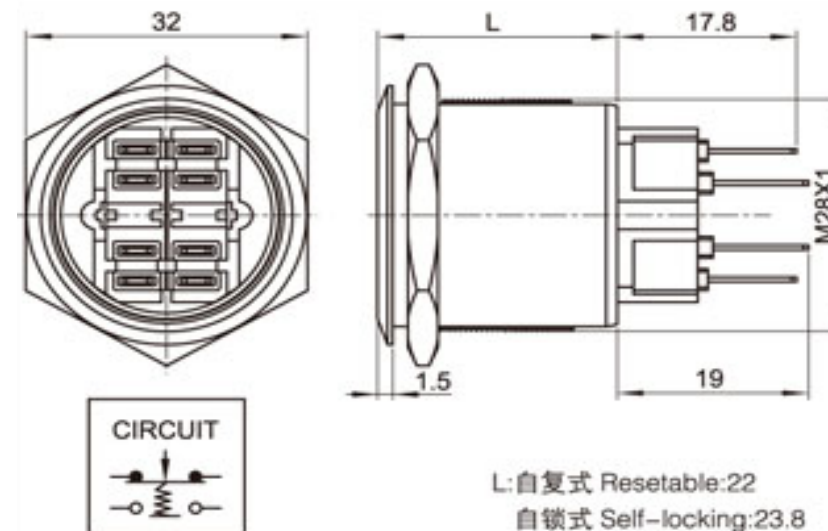

28MM Anti-Vandal-Switch

Part No.: **Q36087-**

Customer:

| | | | | | | | | | |
|-------|--------|------|--------|--------|--------|-----------|-----------|------|------------|
| DRW: | Jason | CHKD | Wilson | MATL: | Wilson | TOLERANCE | Mason | DATE | 18.06.2017 |
| APPD: | Schumi | | | FINISH | Jamy | | Sheet No. | | 1 from 3 |

EDCON-COMPONENTS



Visual Effect of Surface



Nickel - plated brass
(Satin surface)



Stainless steel (Spiral surface)



Gold - plated brass (Satin surface)



G=Gray



B=Black



W=White

Engraving Options

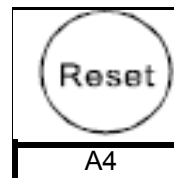

Order Code

A4

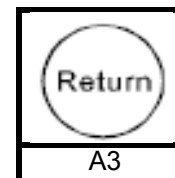

A3

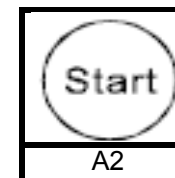

A2

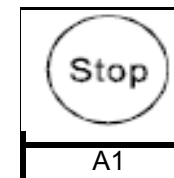

A1

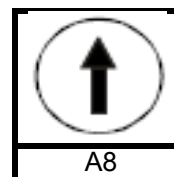

Order Code

A8

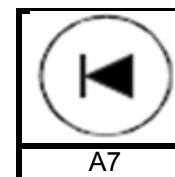

A7

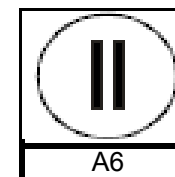

A6

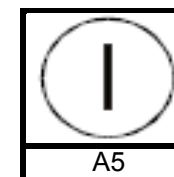

A5

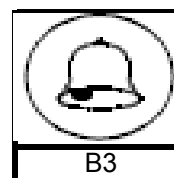

Order Code

B3

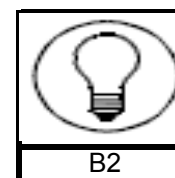

B2

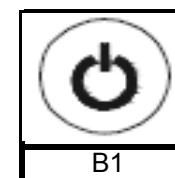

B1

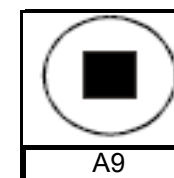

A9

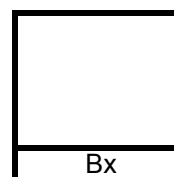

Order Code

Bx

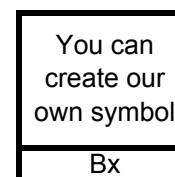

You can create our own symbol

Bx

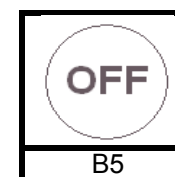

OFF

B5

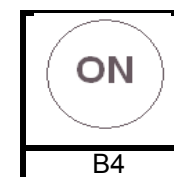

ON

B4

28MM Anti-Vandal-Switch

Part No.: **Q36087-**

| | | | | | | | | | | |
|-------|--------|------|--------|--------|--------|-----------|-----------|------|------------|-----------|
| DRW: | Jason | CHKD | Wilson | MATL: | Wilson | TOLERANCE | Mason | DATE | 18.06.2017 | Customer: |
| APPD: | Schumi | | | FINISH | Jamy | | Sheet No. | | 2 from 3 | |

EDCON-COMPONENTS



Ordering Information

| Serie | Front Shape | Contact Structure | Lamp Type | Connect Type | Knob Color | Lamp Voltage | Crust Material | Engraving Options | ROHS | Packing Style |
|----------------|-------------|-------------------|-----------|--------------|------------|--------------|----------------|-------------------|----------|---------------|
| Q36087- | F | 11 | N | 1 | Y | 0 | N | XX | R | N |

| | | | | | | | | | |
|----------------|--------------------------------|-----------------------|--------------------------------|------------------------|-------------------|-------------------------------|--|----------------------------|------------------------------|
| | | N= no Function | 1= Solder Lug 2,8x0,5mm | A= Same us Body | 0= without | S= Stainless Steel | XX= w/o other Look Order Code Engraving Options | R= ROHS Conform | N= White Carton |
| F= Flat | 11= 1NO/NC | | | | | N= Nickel Plated Brass | | N= NON ROHS Conform | I= Individual Packing |
| | 22= 2NO/NC | | | | | G= Gold Plated Brass | | | |
| | | | | | | | | | |
| | | | | | | | | | |
| | 44= 1NO/NC Self-Locking | | | | | | | | |
| | 55= 2NO/NC Self-Locking | | | | | | | | |

| | |
|--------------------------------|----------------|
| 28MM Anti-Vandal-Switch | |
| Part No.: | Q36087- |
| Customer: | |

| | | | | | | | | | |
|-------|--------|------|--------|--------|--------|-----------|-----------|------|------------|
| DRW: | Jason | CHKD | Wilson | MATL: | Wilson | TOLERANCE | Mason | DATE | 18.06.2017 |
| APPD: | Schumi | | | FINISH | Jamy | | Sheet No. | | 3 from 3 |