

# EDCON-COMPONENTS



## Specifications

Switch Rating: 5A/250VAC  
 Contact Configuration: 1NO/NC / 2NO/NC

IP-Degree: IP67 / IK10  
 Crust Material: Look order Code  
 Terminal Type: Look order Code  
 Switching: Momentary / Self-Locking  
 Contact Resistance:  $\leq 50\text{m}\Omega$   
 Insulation Resistance:  $\geq 1000\text{M}\Omega$   
 Dielectric Strength: 2000VAC  
 Operating Temperature:  $-20^{\circ}\text{C} \sim +55^{\circ}\text{C}$   
 Mechanical Life: 500.000 cycles  
 Electrical Life: 50.000 cycles  
 Panel Thickness: 1 ~ 10mm  
 Nut Torque: 5 ~ 14Nm  
 Operating Pressure: About 3-5Nm

Operating Stroke: About 2,5mm

## Material

Contact: Silver Alloy  
 Button: Look order Code  
 Body: Look order Code  
 Base: PA66  
**ROHS:** Made by Order-Code

## Drawing

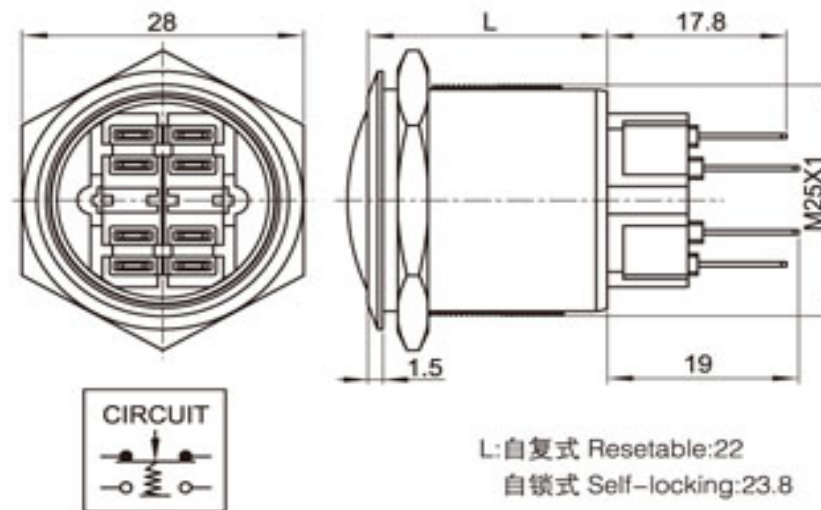

L: 自复式 Resetable: 22  
 自锁式 Self-locking: 23.8

## 25MM Anti-Vandal-Switch

Part No.: **Q36085-**

Customer:

|       |        |      |        |        |        |           |           |          |            |
|-------|--------|------|--------|--------|--------|-----------|-----------|----------|------------|
| DRW:  | Jason  | CHKD | Wilson | MATL:  | Wilson | TOLERANCE | Mason     | DATE     | 18.06.2017 |
| APPD: | Schumi |      |        | FINISH | Jamy   |           | Sheet No. | 1 from 3 |            |

# EDCON-COMPONENTS



## Visual Effect of Surface



Nickel - plated brass  
( Satin surface)



Stainless steel ( Spiral surface)



Gold - plated brass ( Satin surface)



G=Gray



B=Black



W=White

## Engraving Options

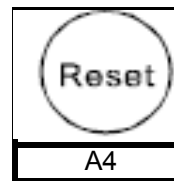

Order Code

A4

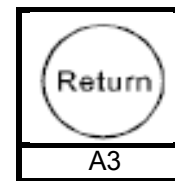

A3

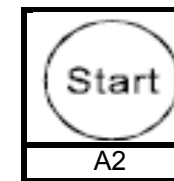

A2

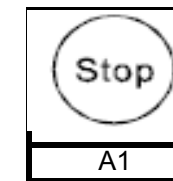

A1

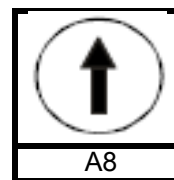

Order Code

A8

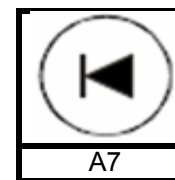

A7

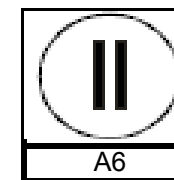

A6

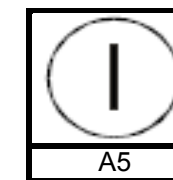

A5

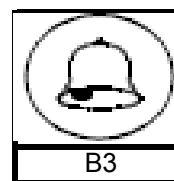

Order Code

B3

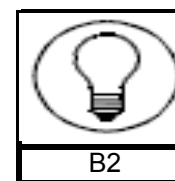

B2

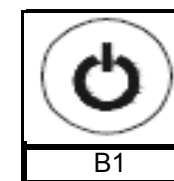

B1

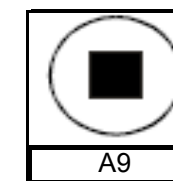

A9

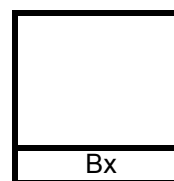

Order Code

Bx

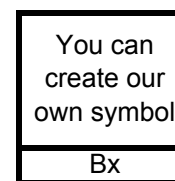

You can create our own symbol

Bx

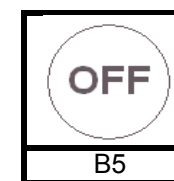

OFF

B5

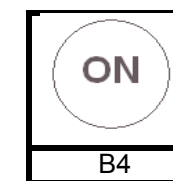

ON

B4

### 25MM Anti-Vandal-Switch

Part No.: **Q36085-**

|       |        |      |        |        |        |           |           |      |            |           |
|-------|--------|------|--------|--------|--------|-----------|-----------|------|------------|-----------|
| DRW:  | Jason  | CHKD | Wilson | MATL:  | Wilson | TOLERANCE | Mason     | DATE | 18.06.2017 | Customer: |
| APPD: | Schumi |      |        | FINISH | Jamy   |           | Sheet No. |      | 2 from 3   |           |

# EDCON-COMPONENTS



## Ordering Information

| Serie          | Front Shape | Contact Structure | Lamp Type | Connect Type | Knob Color | Lamp Voltage | Crust Material | Engraving Options | ROHS     | Packing Style |
|----------------|-------------|-------------------|-----------|--------------|------------|--------------|----------------|-------------------|----------|---------------|
| <b>Q36085-</b> | <b>B</b>    | <b>11</b>         | <b>N</b>  | <b>1</b>     | <b>Y</b>   | <b>0</b>     | <b>N</b>       | <b>XX</b>         | <b>R</b> | <b>N</b>      |

|                 |                                |                       |                                |                        |                   |                               |  |                            |                              |
|-----------------|--------------------------------|-----------------------|--------------------------------|------------------------|-------------------|-------------------------------|--|----------------------------|------------------------------|
|                 |                                | <b>N= no Function</b> | <b>1= Solder Lug 2,8x0,5mm</b> | <b>A= Same us Body</b> | <b>0= without</b> | <b>S= Stainless Steel</b>     | <b>XX= w/o other Look Order Code Engraving Options</b> | <b>R= ROHS Conform</b>     | <b>N= White Carton</b>       |
| <b>B= Domed</b> |                                |                       |                                |                        |                   | <b>N= Nickel Plated Brass</b> |  | <b>N= NON ROHS Conform</b> | <b>I= Individual Packing</b> |
|                 | <b>11= 1NO/NC</b>              |                       |                                |                        |                   |                               |  |                            |                              |
|                 | <b>22= 2NO/NC</b>              |                       |                                |                        |                   | <b>G= Gold Plated Brass</b>   |  |                            |                              |
|                 |                                |                       |                                |                        |                   |                               |  |                            |                              |
|                 |                                |                       |                                |                        |                   |                               |  |                            |                              |
|                 | <b>44= 1NO/NC Self-Locking</b> |                       |                                |                        |                   |                               |  |                            |                              |
|                 | <b>55= 2NO/NC Self-Locking</b> |                       |                                |                        |                   |                               |  |                            |                              |

|                                |                |
|--------------------------------|----------------|
| <b>25MM Anti-Vandal-Switch</b> |                |
| Part No.:                      | <b>Q36085-</b> |
| Customer:                      |                |

|       |        |      |        |        |        |           |           |      |            |
|-------|--------|------|--------|--------|--------|-----------|-----------|------|------------|
| DRW:  | Jason  | CHKD | Wilson | MATL:  | Wilson | TOLERANCE | Mason     | DATE | 18.06.2017 |
| APPD: | Schumi |      |        | FINISH | Jamy   |           | Sheet No. |      | 3 from 3   |