

EDCON-COMPONENTS



Specifications

Switch Rating: 5A/250VAC
 Contact Configuration: 1NO

 IP-Degree: IP67 / IK10
 Crust Material: Look order Code
 Terminal Type: Look order Code
 Switching: Momentary
 Contact Resistance: ≤ 50mΩ
 Insulation Resistance: ≥ 1000MΩ
 Dielectric Strength: 2000VAC
 Operating Temperature: -20°C ~ +55°C
 Mechanical Life: 500.000 cycles
 Electrical Life: 50.000 cycles
 Panel Thickness: 1 ~ 10mm
 Nut Torque: 5 ~ 14Nm
 Operating Pressure: About 4Nm

Operating Stroke: About 1,8mm

Material

Contact: Silver Alloy
 Button: Look order Code
 Body: Look order Code
 Base: PA66
ROHS: Made by Order-Code

The button of the button must be secure against rotation

Drawing

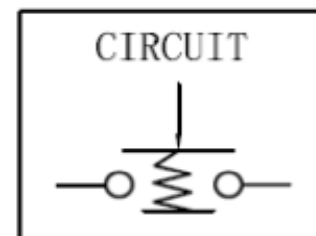
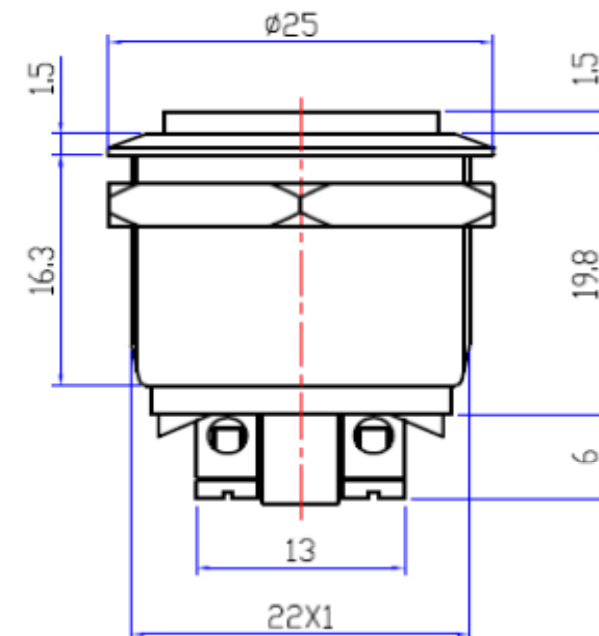

22MM Anti-Vandal-Switch

Part No.: **Q36084-**

Customer:

DRW:	Jason	CHKD	Wilson	MATL:	Wilson	TOLERANCE	Mason	DATE	02.08.2018
APPD:	Schumi			FINISH	Jamy		Sheet No.	1 from 4	

EDCON-COMPONENTS



Visual Effect of Surface



Nickel - plated brass
(Satin surface)



Stainless steel (Spiral surface)



Gold - plated brass (Satin surface)



G=Gray



B=Black



W=White

Engraving Options

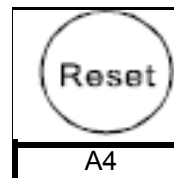

Order Code

A4

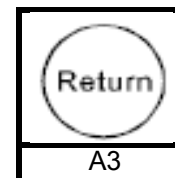

A3

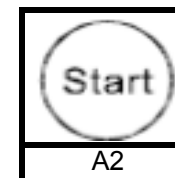

A2

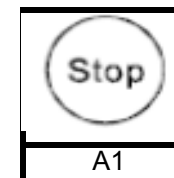

A1

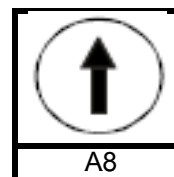

Order Code

A8

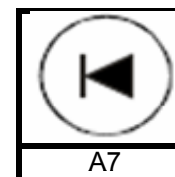

A7

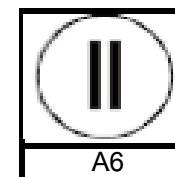

A6

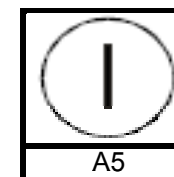

A5

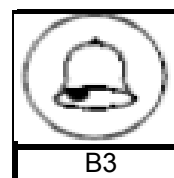

Order Code

B3

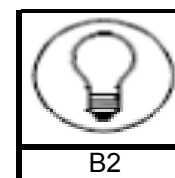

B2

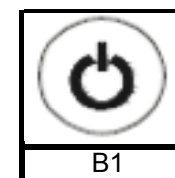

B1

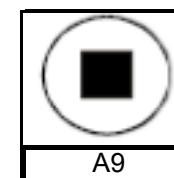

A9

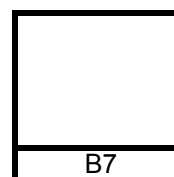

Order Code

B7

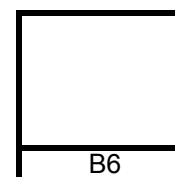

B6

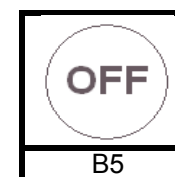

B5

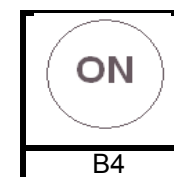

B4

22MM Anti-Vandal-Switch

Part No.: **Q36084-**

DRW:	Jason	CHKD	Wilson	MATL:	Wilson	TOLERANCE	Mason	DATE	02.08.2018	Customer:
APPD:	Schumi			FINISH	Jamy		Sheet No.		2 from 4	

EDCON-COMPONENTS



Order Code Table Engraving Options

		 H= 7mm	 H= 7mm	 H= 7mm	 H= 7mm	 H= 7mm	 H= 7mm	Order Code
 H= 7mm	 H= 7mm	 H= 7mm	 H= 7,5mm	 H= 7,5mm	 H= 7,5mm	 H= 7,5mm		Order Code
								Order Code
								Order Code
								Order Code

22MM Anti-Vandal-Switch	
Part No.:	Q36084-
Customer:	

DRW:	Jason	CHKD	Wilson	MATL:	Wilson	TOLERANCE	Mason	DATE	02.08.2018
APPD:	Schumi			FINISH	Jamy		Sheet No.		2 from 4

EDCON-COMPONENTS



Ordering Information

Serie	Front Shape	Contact Structure	Lamp Type	Connect Type	Knob Color	Lamp Voltage	Crust Material	Engraving Options	ROHS	Packing Style
Q36084-	H	10	N	2	Y	0	N	XX	R	N

H= High	10= 1NO	N= no Function		A= Same us Body	0= without	S= Stainless Steel	XX= w/o other Look Order Code Engraving Options	R= ROHS Conform	N= White Carton
			2= Screw Terminal			N= Nickel Plated Brass		N= NON ROHS Conform	I= Individual Packing
						G= Gold Plated Brass			

22MM Anti-Vandal-Switch

Part No.: **Q36084-**

DRW:	Jason	CHKD	Wilson	MATL:	Wilson	TOLERANCE	Mason	DATE	02.08.2018
APPD:	Schumi			FINISH	Jamy		Sheet No.	4 from 4	

Customer: