

# EDCON-COMPONENTS



## Specifications

Switch Rating:	5A/250VAC
Contact Configuration:	1NO/NC
IP-Degree:	IP67 / IK10
Crust Material:	Look order Code
Terminal Type:	Look order Code
Switching:	Momentary / Self-Locking
Contact Resistance:	≤ 50mΩ
Insulation Resistance:	≥ 1000MΩ
Dielectric Strength:	2000VAC
Operating Temperature:	-20°C ~ +55°C
Mechanical Life:	500.000 cycles
Electrical Life:	50.000 cycles
Panel Thickness:	1 ~ 10mm
Nut Torque:	5 ~ 14Nm
Operating Pressure:	About 3~5Nm

Operating Stroke: About 2,5mm

## Material

Contact:	Silver Alloy
Button:	Look order Code
Body:	Look order Code
Base:	PA66
<b>ROHS:</b>	Made by Order-Code

## Drawing

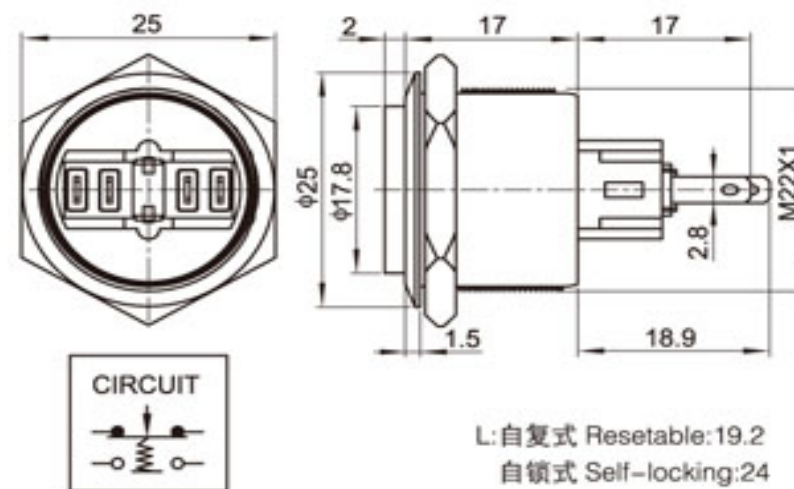

L: 自复式 Resetable: 19.2  
自锁式 Self-locking: 24

## 22MM Anti-Vandal-Switch

Part No.: **Q36081-**

Customer:

DRW:	Jason	CHKD	Wilson	MATL:	Wilson	TOLERANCE	Mason	DATE	18.06.2017
APPD:	Schumi			FINISH	Jamy		Sheet No.		1 from 3

[www.edcon-components.com](http://www.edcon-components.com)

email: [info@edcon-components.com](mailto:info@edcon-components.com)

# EDCON-COMPONENTS



## Visual Effect of Surface



Nickel - plated brass  
( Satin surface)



Stainless steel (Spiral surface)



Gold - plated brass (Satin surface)



G=Gray



B=Black



W=White

## Engraving Options

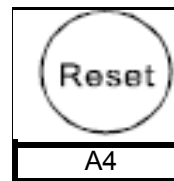

Order Code

A4

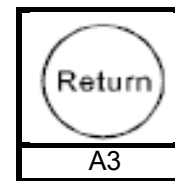

Order Code

A3

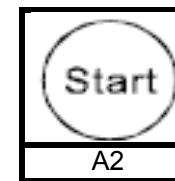

Order Code

A2

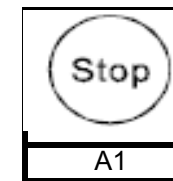

Order Code

A1

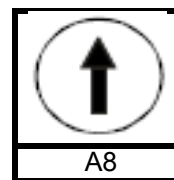

Order Code

A8

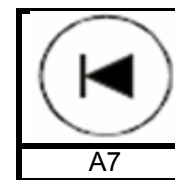

Order Code

A7

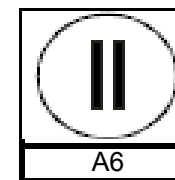

Order Code

A6

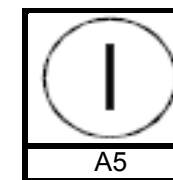

Order Code

A5

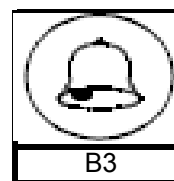

Order Code

B3

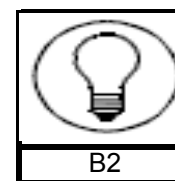

Order Code

B2

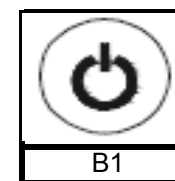

Order Code

B1

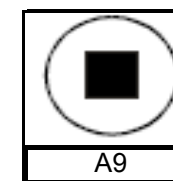

Order Code

A9

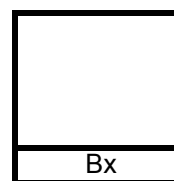

Order Code

Bx

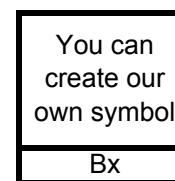

You can create our own symbol

Order Code

Bx

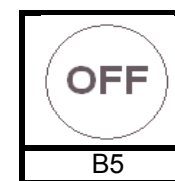

OFF

Order Code

B5

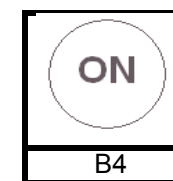

ON

Order Code

B4

**22MM Anti-Vandal-Switch**

Part No.: **Q36081-**

DRW:	Jason	CHKD	Wilson	MATL:	Wilson	TOLERANCE	Mason	DATE	18.06.2017	Customer:
APPD:	Schumi			FINISH	Jamy		Sheet No.		2 from 3	

# EDCON-COMPONENTS



## Ordering Information

Serie	Front Shape	Contact Structure	Lamp Type	Connect Type	Knob Color	Lamp Voltage	Crust Material	Engraving Options	ROHS	Packing Style
<b>Q36081-</b>	<b>H</b>	<b>11</b>	<b>N</b>	<b>1</b>	<b>Y</b>	<b>0</b>	<b>N</b>	<b>XX</b>	<b>R</b>	<b>N</b>

<b>H= High</b>		<b>N= no Function</b>	<b>1= Solder Lug 2,8x0,5mm</b>	<b>A= Same us Body</b>	<b>0= without</b>	<b>S= Stainless Steel</b>	<b>XX= w/o other Look Order Code Engraving Options</b>	<b>R= ROHS Conform</b>	<b>N= White Carton</b>
						<b>N= Nickel Plated Brass</b>		<b>N= NON ROHS Conform</b>	<b>I= Individual Packing</b>
	<b>11= 1NO/NC</b>					<b>G= Gold Plated Brass</b>			
	<b>44= 1NO/NC Self-Locking</b>								

<b>22MM Anti-Vandal-Switch</b>	
Part No.:	<b>Q36081-</b>
Customer:	

DRW:	Jason	CHKD	Wilson	MATL:	Wilson	TOLERANCE	Mason	DATE	18.06.2017
APPD:	Schumi			FINISH	Jamy		Sheet No.		3 from 3