

EDCON-COMPONENTS



Specifications

Switch Rating:	5A/250VAC
Contact Configuration:	1NO/NC
IP-Degree:	IP67 / IK10
Crust Material:	Look order Code
Terminal Type:	Look order Code
Switching:	Momentary / Self-Locking
Contact Resistance:	≤ 50mΩ
Insulation Resistance:	≥ 1000MΩ
Dielectric Strength:	2000VAC
Operating Temperature:	-20°C ~ +55°C
Mechanical Life:	500.000 cycles
Electrical Life:	50.000 cycles
Panel Thickness:	1 ~ 10mm
Nut Torque:	5 ~ 14Nm
Operating Pressure:	About 3~5Nm

Operating Stroke: About 2,5mm

Material

Contact:	Silver Alloy
Button:	Look order Code
Body:	Look order Code
Base:	PA66
ROHS:	Made by Order-Code

Drawing

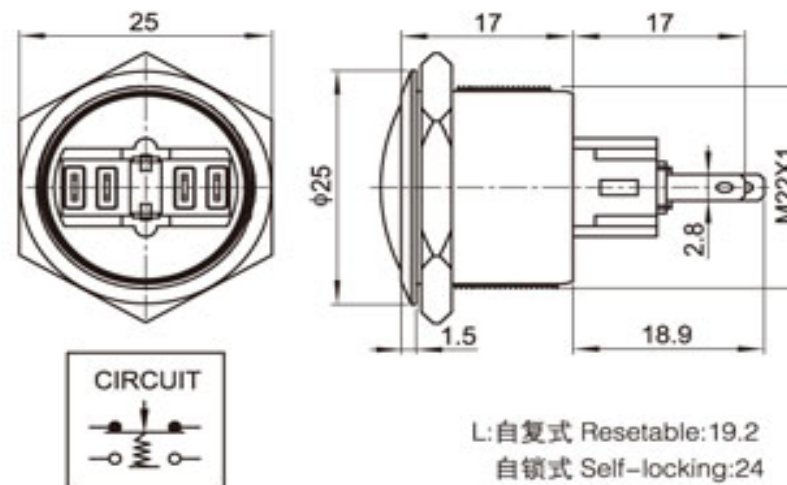

22MM Anti-Vandal-Switch

Part No.: **Q36080-**

Customer:

DRW:	Jason	CHKD	Wilson	MATL:	Wilson	TOLERANCE	Mason	DATE	18.06.2017
APPD:	Schumi			FINISH	Jamy		Sheet No.		1 from 3

www.edcon-components.com

email: info@edcon-components.com

EDCON-COMPONENTS



Visual Effect of Surface



Nickel - plated brass
(Satin surface)



Stainless steel (Spiral surface)



Gold - plated brass (Satin surface)



G=Gray



B=Black



W=White

Engraving Options

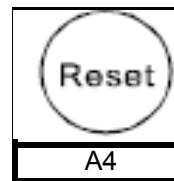

Order Code

A4

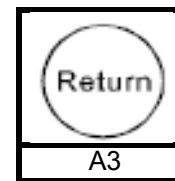

A3

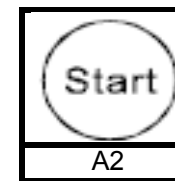

A2

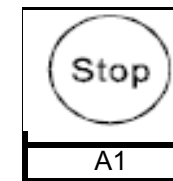

A1

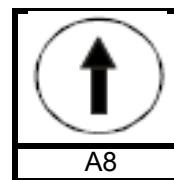

Order Code

A8

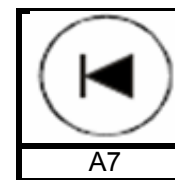

A7

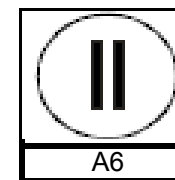

A6

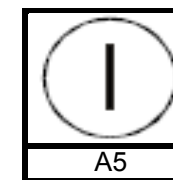

A5

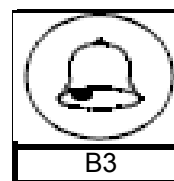

Order Code

B3

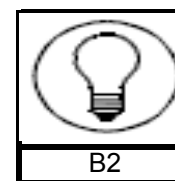

B2

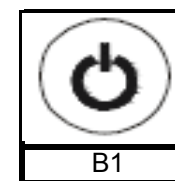

B1

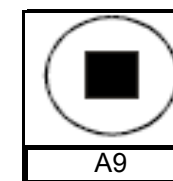

A9

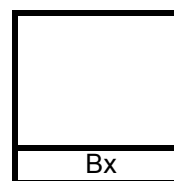

Order Code

Bx

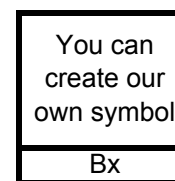

Bx

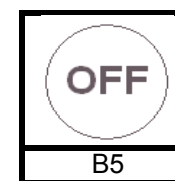

B5

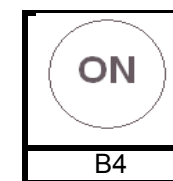

B4

22MM Anti-Vandal-Switch

Part No.: **Q36080-**

DRW:	Jason	CHKD	Wilson	MATL:	Wilson	TOLERANCE	Mason	DATE	18.06.2017	Customer:
APPD:	Schumi			FINISH	Jamy		Sheet No.		2 from 3	

EDCON-COMPONENTS



Ordering Information

Serie	Front Shape	Contact Structure	Lamp Type	Connect Type	Knob Color	Lamp Voltage	Crust Material	Engraving Options	ROHS	Packing Style
Q36080-	B	11	N	1	Y	0	N	XX	R	N

		N= no Function	1= Solder Lug 2,8x0,5mm	A= Same us Body	0= without	S= Stainless Steel	XX= w/o other Look Order Code Engraving Options	R= ROHS Conform	N= White Carton
B= Domed						N= Nickel Plated Brass		N= NON ROHS Conform	I= Individual Packing
	11= 1NO/NC					G= Gold Plated Brass			
	44= 1NO/NC Self-Locking								

22MM Anti-Vandal-Switch

Part No.: **Q36080-**

DRW:	Jason	CHKD	Wilson	MATL:	Wilson	TOLERANCE	Mason	DATE	18.06.2017
APPD:	Schumi			FINISH	Jamy			Sheet No.	3 from 3

Customer: