

# EDCON-COMPONENTS



## Specifications

Switch Rating:	5A/250VAC
Contact Configuration:	1NO/NC 2NO/NC
IP-Degree:	IP65 / IK08
Crust Material:	Look order Code
Terminal Type:	Look order Code
Switching:	Momentary / Self-Locking
Contact Resistance:	≤ 50mΩ
Insulation Resistance:	≥ 1000MΩ
Dielectric Strength:	2000VAC
Operating Temperature:	. -20°C ~ +55°C
Mechanical Life:	500.000 cycles
Electrical Life:	50.000 cycles
Panel Thickness:	1 ~ 10mm
Nut Torque:	5 ~ 14Nm
Operating Pressure:	About 3~5Nm

Operating Stroke: About 2,5mm

## Material

Contact:	Silver Alloy
Button:	Look order Code
Body:	Look order Code
Base:	PA66
<b>ROHS:</b>	Made by Order-Code

## Drawing

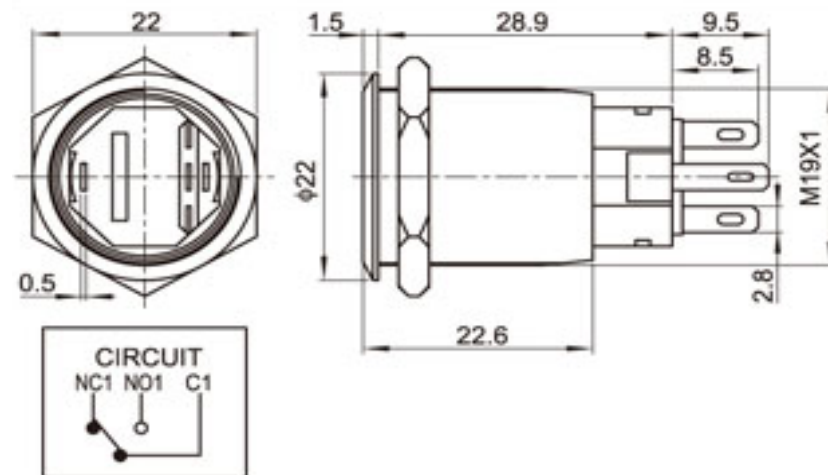

## 19MM Anti-Vandal-Switch

Part No.: **Q36077-**

Customer:

DRW:	Jason	CHKD	Wilson	MATL:	Wilson	TOLERANCE	Mason	DATE	18.06.2017
APPD:	Schumi			FINISH	Jamy		Sheet No.		1 from 3

# EDCON-COMPONENTS



## Visual Effect of Surface



Nickel - plated brass  
( Satin surface)



Stainless steel ( Spiral surface)



Gold - plated brass ( Satin surface)



G=Gray



B=Black



W=White

## Engraving Options

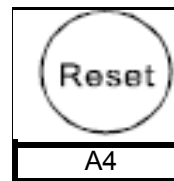

Order Code

A4

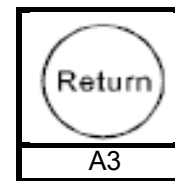

A3

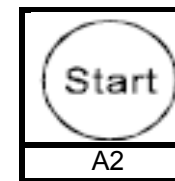

A2

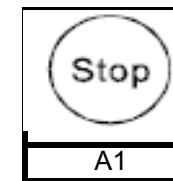

A1

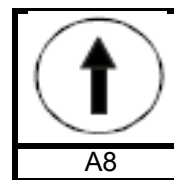

Order Code

A8

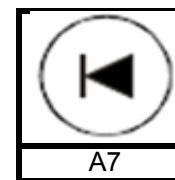

A7

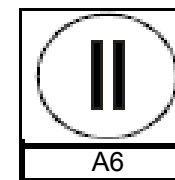

A6

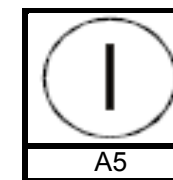

A5

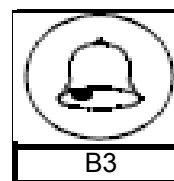

Order Code

B3

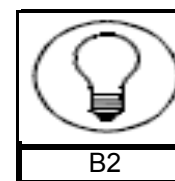

B2

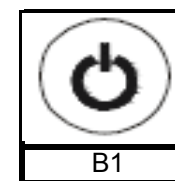

B1

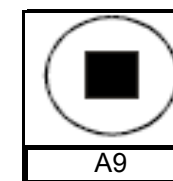

A9

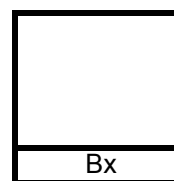

Order Code

Bx

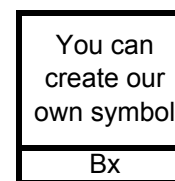

Bx

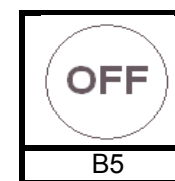

B5

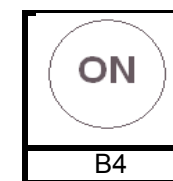

B4

**19MM Anti-Vandal-Switch**

Part No.: **Q36077-**

DRW:	Jason	CHKD	Wilson	MATL:	Wilson	TOLERANCE	Mason	DATE	18.06.2017	Customer:
APPD:	Schumi			FINISH	Jamy		Sheet No.		2 from 3	

[www.edcon-components.com](http://www.edcon-components.com)

email: [info@edcon-components.com](mailto:info@edcon-components.com)

# EDCON-COMPONENTS



## Ordering Information

Serie	Front Shape	Contact Structure	Lamp Type	Connect Type	Knob Color	Lamp Voltage	Crust Material	Engraving Options	ROHS	Packing Style
<b>Q36077-</b>	<b>F</b>	<b>44</b>	<b>N</b>	<b>1</b>	<b>Y</b>	<b>0</b>	<b>N</b>	<b>XX</b>	<b>R</b>	<b>N</b>

		<b>N= no Function</b>	<b>1= Solder Lug 2,8x0,5mm</b>	<b>A= Same us Body</b>	<b>0= without</b>	<b>S= Stainless Steel</b>	<b>XX= w/o other Look Order Code Engraving Options</b>	<b>R= ROHS Conform</b>	<b>N= White Carton</b>
<b>F= Flat</b>	<b>11= 1NO1NC</b>					<b>N= Nickel Plated Brass</b>			
	<b>22= 2NO2NC</b>					<b>G= Gold Plated Brass</b>		<b>N= NON ROHS Conform</b>	<b>I= Individual Packing</b>
	<b>44= 1NO/NC Self-Locking</b>								
	<b>55= 2NO/NC Self-Locking</b>								

<b>19MM Anti-Vandal-Switch</b>	
Part No.:	<b>Q36077-</b>
Customer:	

DRW:	Jason	CHKD	Wilson	MATL:	Wilson	TOLERANCE	Mason	DATE	18.06.2017
APPD:	Schumi			FINISH	Jamy		Sheet No.	3 from 3	