

# EDCON-COMPONENTS



## Specifications

Switch Rating: 3A/250VAC  
 Contact Configuration: 1NO  
  
 IP-Degree: IP65 / IK08  
 Crust Material: Look order Code  
 Terminal Type: Look order Code  
 Switching: Momentary  
 Contact Resistance:  $\leq 50\text{m}\Omega$   
 Insulation Resistance:  $\geq 1000\text{M}\Omega$   
 Dielectric Strength: 2000VAC  
 Operating Temperature:  $-20^{\circ}\text{C} \sim +55^{\circ}\text{C}$   
 Mechanical Life: 500.000 cycles  
 Electrical Life: 50.000 cycles  
 Panel Thickness: 1 ~ 10mm  
 Nut Torque: 5 ~ 14Nm  
 Operating Pressure: About 4N

Operating Stroke: About 1,8mm

## Material

Contact: Silver Alloy  
 Button: Look order Code  
 Body: Look order Code  
 Base: PA66  
**ROHS:** Made by Order-Code

## Drawing

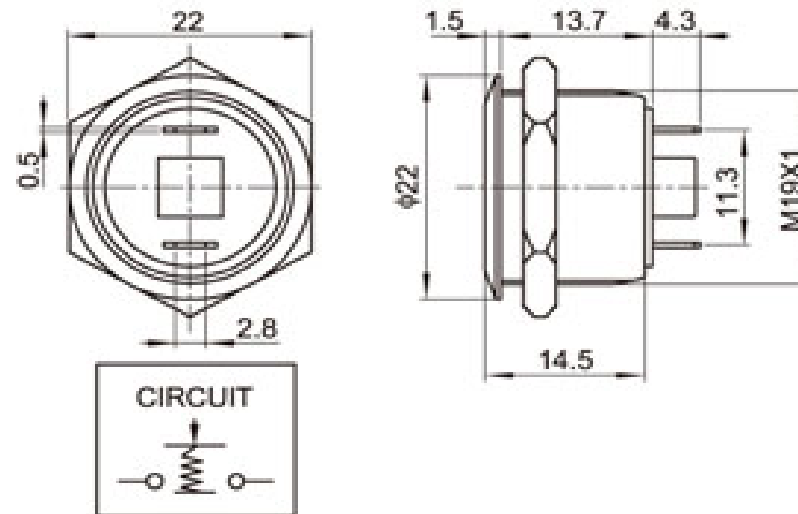

## 19MM Anti-Vandal-Switch

Part No.: **Q36074-**

Customer:

|       |        |      |        |        |        |           |           |          |            |
|-------|--------|------|--------|--------|--------|-----------|-----------|----------|------------|
| DRW:  | Jason  | CHKD | Wilson | MATL:  | Wilson | TOLERANCE | Mason     | DATE     | 18.06.2017 |
| APPD: | Schumi |      |        | FINISH | Jamy   |           | Sheet No. | 1 from 3 |            |

# EDCON-COMPONENTS



## Visual Effect of Surface



Nickel - plated brass  
( Satin surface)



Stainless steel ( Spiral surface)



Gold - plated brass ( Satin surface)



G=Gray



B=Black



W=White

## Engraving Options

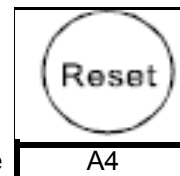

Order Code

A4

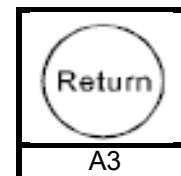

A3

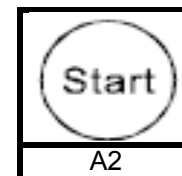

A2

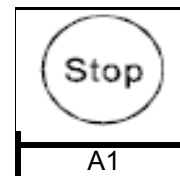

A1

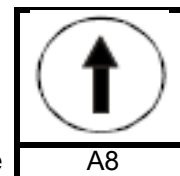

Order Code

A8

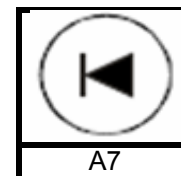

A7

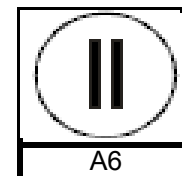

A6

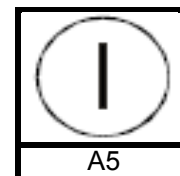

A5

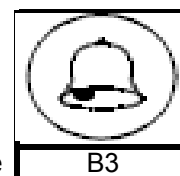

Order Code

B3

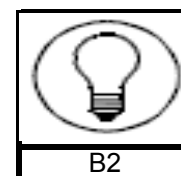

B2

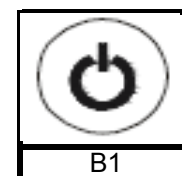

B1

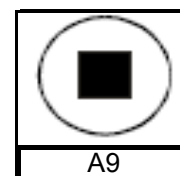

A9

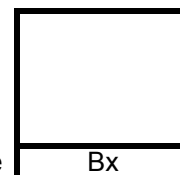

Order Code

Bx

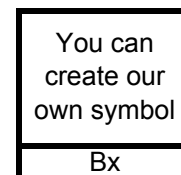

Bx

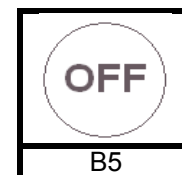

B5

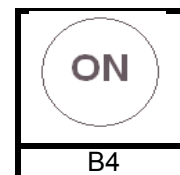

B4

|                                |                |
|--------------------------------|----------------|
| <b>19MM Anti-Vandal-Switch</b> |                |
| Part No.:                      | <b>Q36074-</b> |
| Customer:                      |                |

|       |        |      |        |        |        |           |           |      |            |
|-------|--------|------|--------|--------|--------|-----------|-----------|------|------------|
| DRW:  | Jason  | CHKD | Wilson | MATL:  | Wilson | TOLERANCE | Mason     | DATE | 18.06.2017 |
| APPD: | Schumi |      |        | FINISH | Jamy   |           | Sheet No. |      | 2 from 3   |

# EDCON-COMPONENTS



## Ordering Information

| Serie          | Front Shape | Contact Structure | Lamp Type | Connect Type | Knob Color | Lamp Voltage | Crust Material | Engraving Options | ROHS     | Packing Style |
|----------------|-------------|-------------------|-----------|--------------|------------|--------------|----------------|-------------------|----------|---------------|
| <b>Q36074-</b> | <b>F</b>    | <b>10</b>         | <b>N</b>  | <b>1</b>     | <b>Y</b>   | <b>0</b>     | <b>N</b>       | <b>XX</b>         | <b>R</b> | <b>N</b>      |

|                |                |                       |                                   |                        |                   |                               |  |                        |                        |
|----------------|----------------|-----------------------|-----------------------------------|------------------------|-------------------|-------------------------------|--|------------------------|------------------------|
|                | <b>10=</b> 1NO | <b>N=</b> no Function | <b>1=</b> Solder Lug<br>2,8x0,5mm | <b>A=</b> Same us Body | <b>0=</b> without | <b>S=</b> Stainless Steel     | <b>XX=</b> w/o other Look Order Code Engraving Options | <b>R=</b> ROHS Conform | <b>N=</b> White Carton |
| <b>F=</b> Flat |                |                       |                                   |                        |                   | <b>N=</b> Nickel Plated Brass |  |                        |                        |
|                |                |                       |                                   |                        |                   | <b>G=</b> Gold Plated Brass   |  |                        |                        |
|                |                |                       |                                   |                        |                   |                               |  |                        |                        |
|                |                |                       |                                   |                        |                   |                               |  |                        |                        |
|                |                |                       |                                   |                        |                   |                               |  |                        |                        |
|                |                |                       |                                   |                        |                   |                               |  |                        |                        |
|                |                |                       |                                   |                        |                   |                               |  |                        |                        |

**19MM Anti-Vandal-Switch**

Part No.: **Q36074-**

|       |        |      |        |        |        |           |           |      |            |
|-------|--------|------|--------|--------|--------|-----------|-----------|------|------------|
| DRW:  | Jason  | CHKD | Wilson | MATL:  | Wilson | TOLERANCE | Mason     | DATE | 18.06.2017 |
| APPD: | Schumi |      |        | FINISH | Jamy   |           | Sheet No. |      | 3 from 3   |

Customer: