

EDCON-COMPONENTS



Specifications

Switch Rating: 3A/250VAC
 Contact Configuration: 1NO

 IP-Degree: IP65 / IK08
 Crust Material: Look order Code
 Terminal Type: Look order Code
 Switching: Momentary
 Contact Resistance: $\leq 50\text{m}\Omega$
 Insulation Resistance: $\geq 1000\text{M}\Omega$
 Dielectric Strength: 2000VAC
 Operating Temperature: $-20^{\circ}\text{C} \sim +55^{\circ}\text{C}$
 Mechanical Life: 500.000 cycles
 Electrical Life: 50.000 cycles
 Panel Thickness: 1 ~ 10mm
 Nut Torque: 5 ~ 14Nm
 Operating Pressure: About 4N

Operating Stroke: About 1,8mm

Material

Contact: Silver Alloy
 Button: Look order Code
 Body: Look order Code
 Base: PA66
ROHS: Made by Order-Code

Drawing

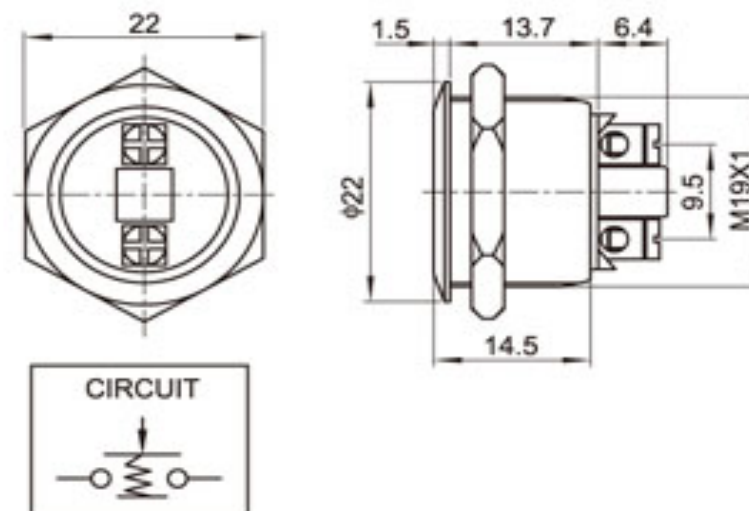

19MM Anti-Vandal-Switch

Part No.: **Q36071-**

Customer:

DRW:	Jason	CHKD	Wilson	MATL:	Wilson	TOLERANCE	Mason	DATE	18.06.2017
APPD:	Schumi			FINISH	Jamy		Sheet No.	1 from 3	

EDCON-COMPONENTS



Visual Effect of Surface



Nickel - plated brass
(Satin surface)



Stainless steel (Spiral surface)



Gold - plated brass (Satin surface)



G=Gray



B=Black



W=White

Engraving Options

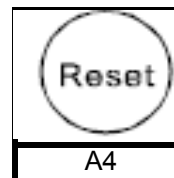

Order Code

A4

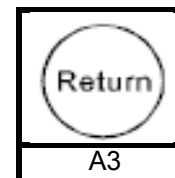

A3

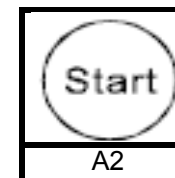

A2

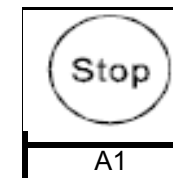

A1

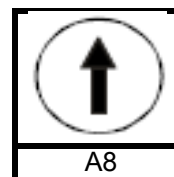

Order Code

A8

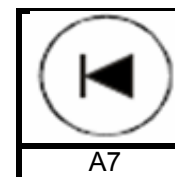

A7

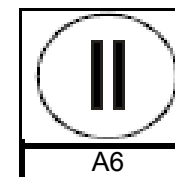

A6

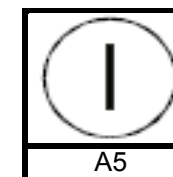

A5

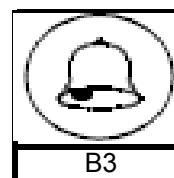

Order Code

B3

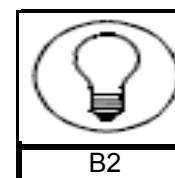

B2

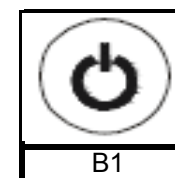

B1

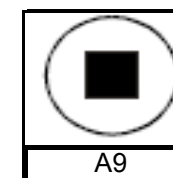

A9

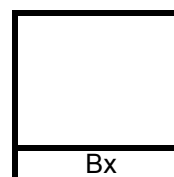

Order Code

Bx

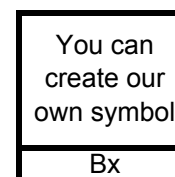

Bx

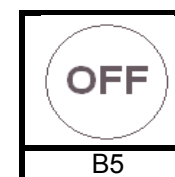

B5

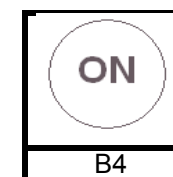

B4

19MM Anti-Vandal-Switch

Part No.: **Q36071-**

DRW:	Jason	CHKD	Wilson	MATL:	Wilson	TOLERANCE	Mason	DATE	18.06.2017	Customer:
APPD:	Schumi			FINISH	Jamy		Sheet No.		2 from 3	

www.edcon-components.com

email: info@edcon-components.com

EDCON-COMPONENTS



Ordering Information

Serie	Front Shape	Contact Structure	Lamp Type	Connect Type	Knob Color	Lamp Voltage	Crust Material	Engraving Options	ROHS	Packing Style
Q36071-	F	10	N	2	Y	0	N	XX	R	N

	10= 1NO	N= no Function		A= Same us Body	0= without	S= Stainless Steel	XX= w/o other Look Order Code Engraving Options	R= ROHS Conform	N= White Carton
F= Flat			2= Screw Terminal			N= Nickel Plated Brass		N= NON ROHS Conform	I= Individual Packing
						G= Gold Plated Brass			

19MM Anti-Vandal-Switch	
Part No.:	Q36071-
Customer:	

DRW:	Jason	CHKD	Wilson	MATL:	Wilson	TOLERANCE	Mason	DATE	18.06.2017
APPD:	Schumi			FINISH	Jamy		Sheet No.	3 from 3	