

# EDCON-COMPONENTS



## Specifications

Switch Rating:	2A/36VDC
Contact Configuration:	1NO
IP-Degree:	IP67 / IK08
Crust Material:	Look order Code
Terminal Type:	Look order Code
Switching:	Self-Locking
Contact Resistance:	≤ 50mΩ
Insulation Resistance:	≥ 1000MΩ
Dielectric Strength:	2000VAC
Operating Temperature:	. -20°C ~ +55°C
Mechanical Life:	500.000 cycles
Electrical Life:	50.000 cycles
Panel Thickness:	1 ~ 10mm
Nut Torque:	5 ~ 14Nm
Operating Pressure:	About 5N
Operating Stroke:	About 1,5mm

## Material

Contact:	Silver Alloy
Button:	Look order Code
Body:	Look order Code
Base:	PA66
<b>ROHS:</b>	Made by Order-Code

## Drawing

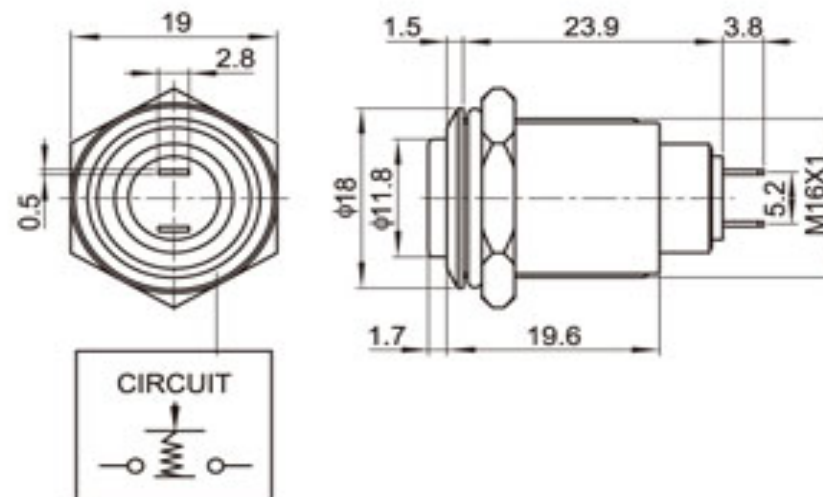

## 16MM Anti-Vandal-Switch

Part No.: **Q36067-**

Customer:

DRW:	Jason	CHKD	Wilson	MATL:	Wilson	TOLERANCE	Mason	DATE	18.06.2017
APPD:	Schumi			FINISH	Jamy		Sheet No.		1 from 3

# EDCON-COMPONENTS



## Visual Effect of Surface



Nickel - plated brass  
( Satin surface)



Stainless steel ( Spiral surface)



Gold - plated brass ( Satin surface)



G=Gray



B=Black



W=White

## Engraving Options

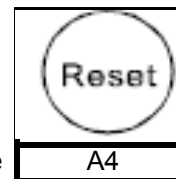

Order Code

A4

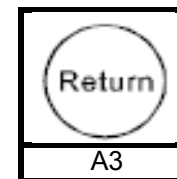

A3

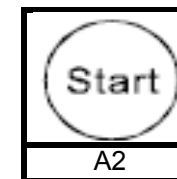

A2

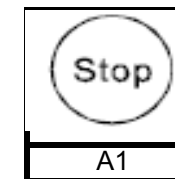

A1

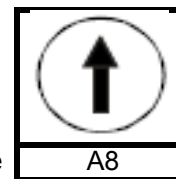

Order Code

A8

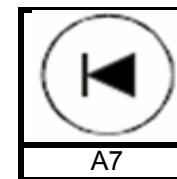

A7

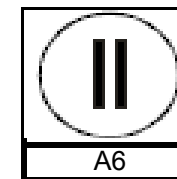

A6

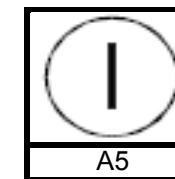

A5

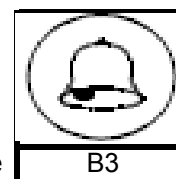

Order Code

B3

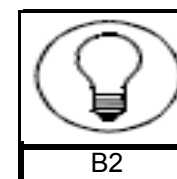

B2

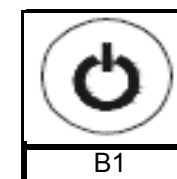

B1

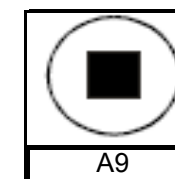

A9

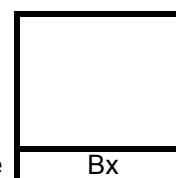

Order Code

Bx

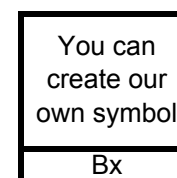

You can create our own symbol

Bx

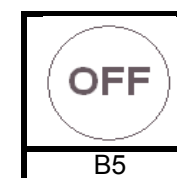

OFF

B5

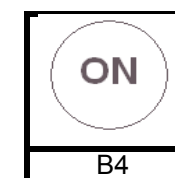

ON

B4

### 16MM Anti-Vandal-Switch

Part No.: **Q36067-**

DRW:	Jason	CHKD	Wilson	MATL:	Wilson	TOLERANCE	Mason	DATE	18.06.2017	Customer:
APPD:	Schumi			FINISH	Jamy		Sheet No.		2 from 3	

