

EDCON-COMPONENTS



Specifications

Switch Rating: 2A/36VDC
 Contact Configuration: 1NO

 IP-Degree: IP67 / IK08
 Crust Material: Look order Code
 Terminal Type: Look order Code
 Switching: Self-Locking
 Contact Resistance: $\leq 50\text{m}\Omega$
 Insulation Resistance: $\geq 1000\text{M}\Omega$
 Dielectric Strength: 2000VAC
 Operating Temperature: $-20^{\circ}\text{C} \sim +55^{\circ}\text{C}$
 Mechanical Life: 500.000 cycles
 Electrical Life: 50.000 cycles
 Panel Thickness: 1 ~ 10mm
 Nut Torque: 5 ~ 14Nm
 Operating Pressure: About 5N

Operating Stroke: About 1,5mm

Material

Contact: Silver Alloy
 Button: Look order Code
 Body: Look order Code
 Base: PA66
ROHS: Made by Order-Code

Drawing

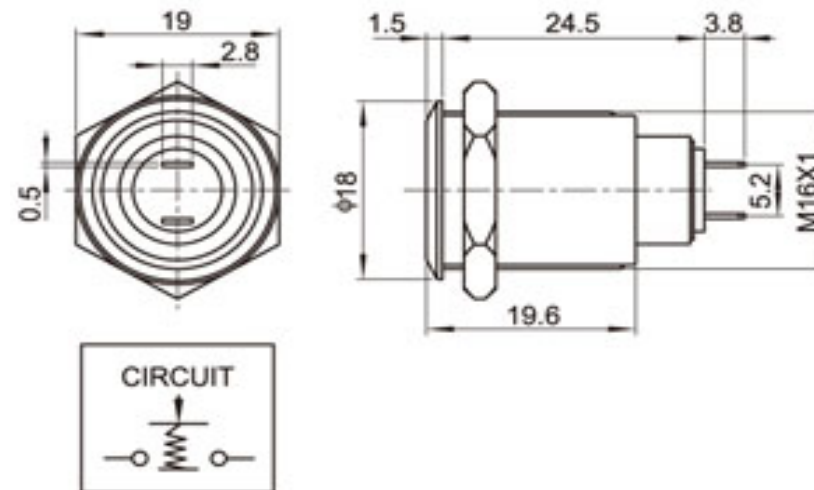

16MM Anti-Vandal-Switch

Part No.: **Q36066-**

DRW:	Jason	CHKD	Wilson	MATL:	Wilson	TOLERANCE	Mason	DATE	18.06.2017	Customer:
APPD:	Schumi			FINISH	Jamy		Sheet No.	1 from 3		

EDCON-COMPONENTS



Visual Effect of Surface



Nickel - plated brass
(Satin surface)



Stainless steel (Spiral surface)



Gold - plated brass (Satin surface)



G=Gray



B=Black



W=White

Engraving Options

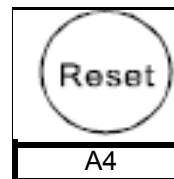

Order Code

A4

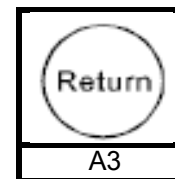

A3

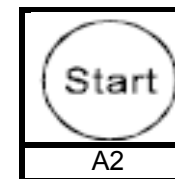

A2

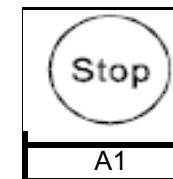

A1

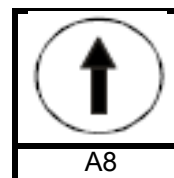

Order Code

A8

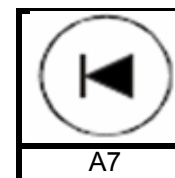

A7

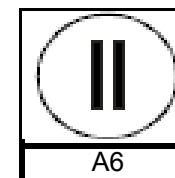

A6

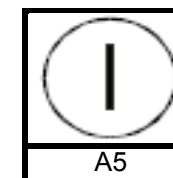

A5

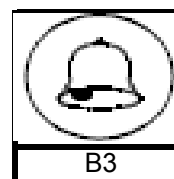

Order Code

B3

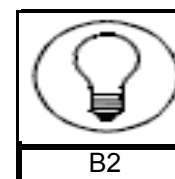

B2

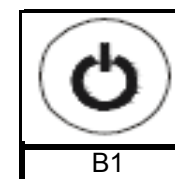

B1

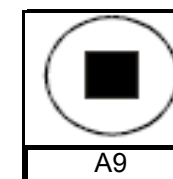

A9

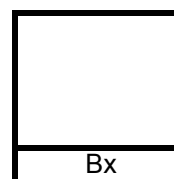

Order Code

Bx

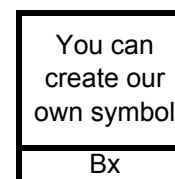

Bx

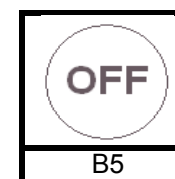

B5

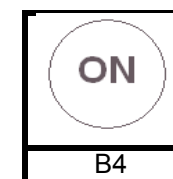

B4

16MM Anti-Vandal-Switch

Part No.: **Q36066-**

DRW:	Jason	CHKD	Wilson	MATL:	Wilson	TOLERANCE	Mason	DATE	18.06.2017	Customer:
APPD:	Schumi			FINISH	Jamy		Sheet No.		2 from 3	

EDCON-COMPONENTS



Ordering Information

Serie	Front Shape	Contact Structure	Lamp Type	Connect Type	Knob Color	Lamp Voltage	Crust Material	Engraving Options	ROHS	Packing Style
Q36066-	F	33	N	1	Y	0	N	XX	R	N

		N= no Function	1= Solder Lug 2,8x0,5mm	A= Same us Body	0= without	S= Stainless Steel	XX= w/o other Look Order Code Engraving Options	R= ROHS Conform	N= White Carton
F= Flat						N= Nickel Plated Brass		N= NON ROHS Conform	I= Individual Packing
						G= Gold Plated Brass			
		33= 1NO Self Locking							

16MM Anti-Vandal-Switch

Part No.: **Q36066-**

Customer:

DRW:	Jason	CHKD	Wilson	MATL:	Wilson	TOLERANCE	Mason	DATE	18.06.2017
APPD:	Schumi			FINISH	Jamy		Sheet No.	3 from 3	