

# EDCON-COMPONENTS



## Specifications

Switch Rating: 2A/36VDC  
 Contact Configuration: 1NO  
  
 IP-Degree: IP67 / IK08  
 Crust Material: Look order Code  
 Terminal Type: Look order Code  
 Switching: Momentary  
 Contact Resistance:  $\leq 50\text{m}\Omega$   
 Insulation Resistance:  $\geq 1000\text{M}\Omega$   
 Dielectric Strength: 2000VAC  
 Operating Temperature:  $-20^{\circ}\text{C} \sim +55^{\circ}\text{C}$   
 Mechanical Life: 500.000 cycles  
 Electrical Life: 50.000 cycles  
 Panel Thickness: 1 ~ 10mm  
 Nut Torque: 5 ~ 14Nm  
 Operating Pressure: About 5N

Operating Stroke: About 1,5mm

## Material

Contact: Silver Alloy  
 Button: Look order Code  
 Body: Look order Code  
 Base: PA66  
**ROHS:** Made by Order-Code

## Drawing

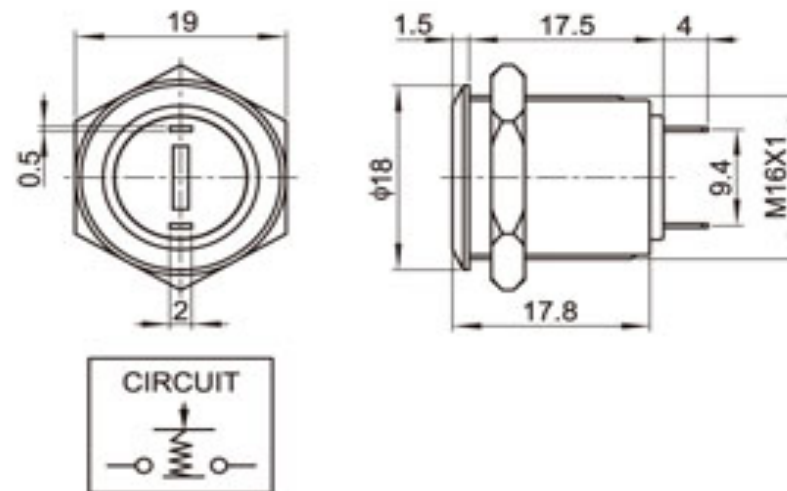

## 16MM Anti-Vandal-Switch

Part No.: **Q36063-**

Customer:

DRW:	Jason	CHKD	Wilson	MATL:	Wilson	TOLERANCE	Mason	DATE	18.06.2017
APPD:	Schumi			FINISH	Jamy		Sheet No.	1 from 3	

# EDCON-COMPONENTS



## Visual Effect of Surface



Nickel - plated brass  
(Satin surface)



Stainless steel (Spiral surface)



Gold - plated brass (Satin surface)



G=Gray



B=Black



W=White

## Engraving Options

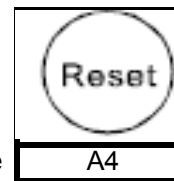

Order Code

A4

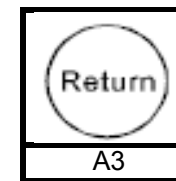

A3

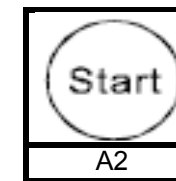

A2

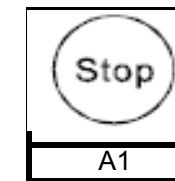

A1

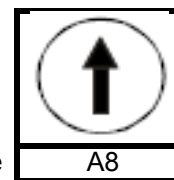

Order Code

A8

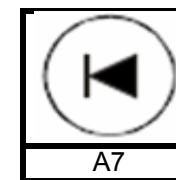

A7

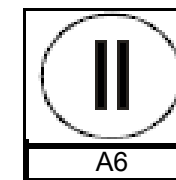

A6

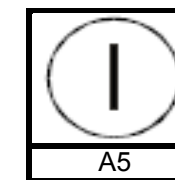

A5

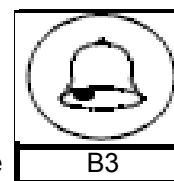

Order Code

B3

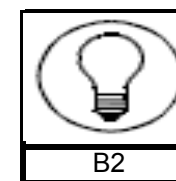

B2

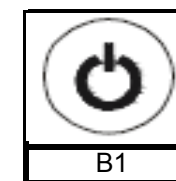

B1

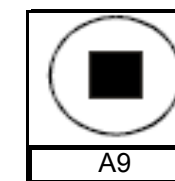

A9

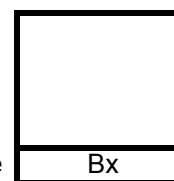

Order Code

Bx

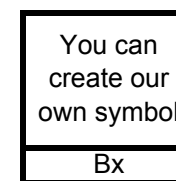

Bx

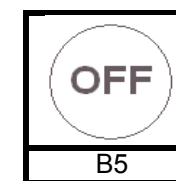

B5

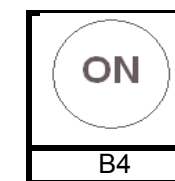

B4

**16MM Anti-Vandal-Switch**

Part No.: **Q36063-**

DRW:	Jason	CHKD	Wilson	MATL:	Wilson	TOLERANCE	Mason	DATE	18.06.2017	Customer:
APPD:	Schumi			FINISH	Jamy		Sheet No.		2 from 3	

# EDCON-COMPONENTS



## Ordering Information

Serie	Front Shape	Contact Structure	Lamp Type	Connect Type	Knob Color	Lamp Voltage	Crust Material	Engraving Options	ROHS	Packing Style
<b>Q36063-</b>	<b>F</b>	<b>10</b>	<b>N</b>	<b>1</b>	<b>Y</b>	<b>0</b>	<b>N</b>	<b>XX</b>	<b>R</b>	<b>N</b>

	<b>10=</b> 1NO	<b>N=</b> no Function	<b>1=</b> Solder Lug 2,0x0,5mm	<b>A=</b> Same us Body	<b>0=</b> without	<b>S=</b> Stainless Steel	<b>XX=</b> w/o other Look Order Code Engraving Options	<b>R=</b> ROHS Conform	<b>N=</b> White Carton
<b>F=</b> Flat						<b>N=</b> Nickel Plated Brass		<b>N=</b> NON ROHS Conform	<b>I=</b> Individual Packing
						<b>G=</b> Gold Plated Brass			

<b>16MM Anti-Vandal-Switch</b>	
Part No.:	<b>Q36063-</b>
Customer:	

DRW:	Jason	CHKD	Wilson	MATL:	Wilson	TOLERANCE	Mason	DATE	18.06.2017
APPD:	Schumi			FINISH	Jamy		Sheet No.	3 from 3	