

# EDCON-COMPONENTS



## Specifications

Switch Rating: 3A/250VAC  
 Contact Configuration: 1NO  
  
 IP-Degree: IP67 / IK08  
 Crust Material: Look order Code  
 Terminal Type: Look order Code  
 Switching: Momentary  
 Contact Resistance:  $\leq 50\text{m}\Omega$   
 Insulation Resistance:  $\geq 1000\text{M}\Omega$   
 Dielectric Strength: 2000VAC  
 Operating Temperature:  $-20^{\circ}\text{C} \sim +55^{\circ}\text{C}$   
 Mechanical Life: 500.000 cycles  
 Electrical Life: 50.000 cycles  
 Panel Thickness: 1 ~ 10mm  
 Nut Torque: 5 ~ 14Nm  
 Operating Pressure: About 5N

Operating Stroke: About 1,5mm

## Material

Contact: Silver Alloy  
 Button: Look order Code  
 Body: Look order Code  
 Base: PA66  
**ROHS:** Made by Order-Code

## Drawing

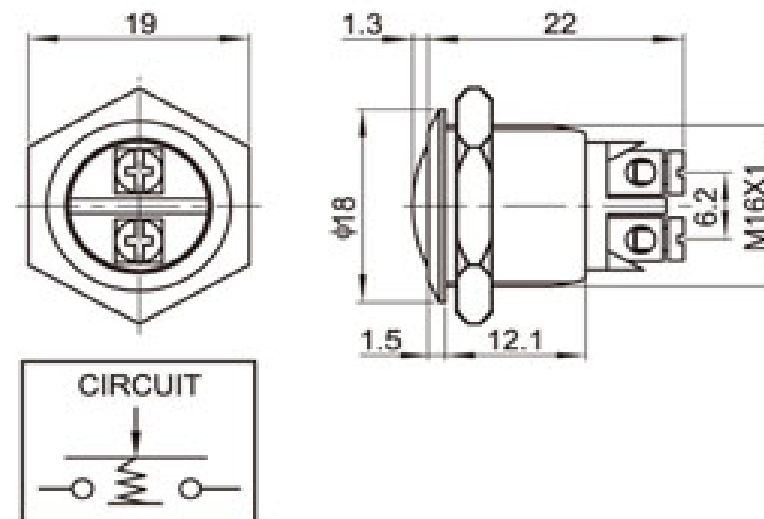

## 16MM Anti-Vandal-Switch

Part No.: **Q36061-**

Customer:

DRW:	Jason	CHKD	Wilson	MATL:	Wilson	TOLERANCE	Mason	DATE	18.06.2017
APPD:	Schumi			FINISH	Jamy		Sheet No.	1 from 3	

# EDCON-COMPONENTS



## Visual Effect of Surface



Nickel - plated brass  
( Satin surface)



Stainless steel ( Spiral surface)



Gold - plated brass ( Satin surface)



G=Gray



B=Black



W=White

## Engraving Options

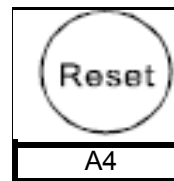

Order Code

A4

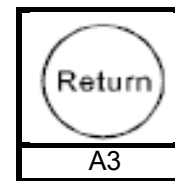

A3

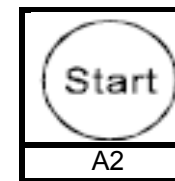

A2

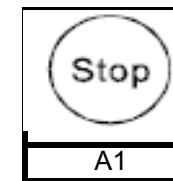

A1

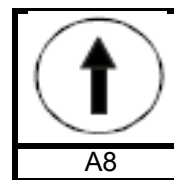

Order Code

A8

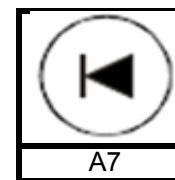

A7

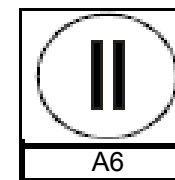

A6

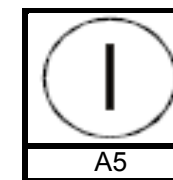

A5

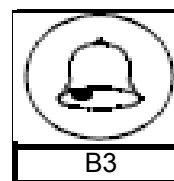

Order Code

B3

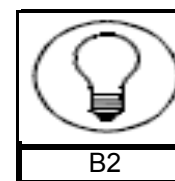

B2

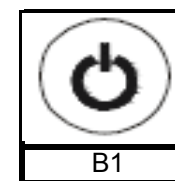

B1

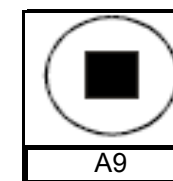

A9

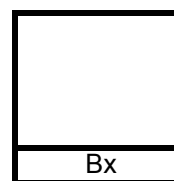

Order Code

Bx

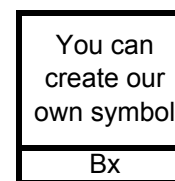

You can create our own symbol

Bx

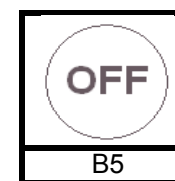

OFF

B5

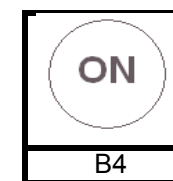

ON

B4

**16MM Anti-Vandal-Switch**

Part No.: **Q36061-**

DRW:	Jason	CHKD	Wilson	MATL:	Wilson	TOLERANCE	Mason	DATE	18.06.2017	Customer:
APPD:	Schumi			FINISH	Jamy		Sheet No.		2 from 3	

# EDCON-COMPONENTS



## Ordering Information

Serie	Front Shape	Contact Structure	Lamp Type	Connect Type	Knob Color	Lamp Voltage	Crust Material	Engraving Options	ROHS	Packing Style
<b>Q36061-</b>	<b>B</b>	<b>10</b>	<b>N</b>	<b>2</b>	<b>Y</b>	<b>0</b>	<b>N</b>	<b>XX</b>	<b>R</b>	<b>N</b>

	<b>10=</b> 1NO	<b>N=</b> no Function		<b>A=</b> Same us Body	<b>0=</b> without	<b>S=</b> Stainless Steel	<b>XX=</b> w/o other Look Order Code Engraving Options	<b>R=</b> ROHS Conform	<b>N=</b> White Carton
<b>B=</b> Domed			<b>2=</b> Screw Terminal			<b>N=</b> Nickel Plated Brass		<b>N=</b> NON ROHS Conform	<b>I=</b> Individual Packing
						<b>G=</b> Gold Plated Brass			

<b>16MM Anti-Vandal-Switch</b>	
Part No.:	<b>Q36061-</b>
Customer:	

DRW:	Jason	CHKD	Wilson	MATL:	Wilson	TOLERANCE	Mason	DATE	18.06.2017
APPD:	Schumi			FINISH	Jamy		Sheet No.		3 from 3