

EDCON-COMPONENTS



Specifications

Switch Rating:	2A/36VDC
Contact Configuration:	1NO
IP-Degree:	IP67 / IK08
Crust Material:	Look order Code
Terminal Type:	Look order Code
Switching:	Self-Locking
Contact Resistance:	≤ 50mΩ
Insulation Resistance:	≥ 1000MΩ
Dielectric Strength:	2000VAC
Operating Temperature:	. -20°C ~ +55°C
Mechanical Life:	500.000 cycles
Electrical Life:	50.000 cycles
Panel Thickness:	1 ~ 6mm
Nut Torque:	5 ~ 14Nm
Operating Pressure:	About 5N
Operating Distance:	About 1,5Nm
Operating Stroke:	About 2,0mm

Material

Contact:	Silver Alloy
Button:	Look order Code
Body:	Look order Code
Base:	PA66
ROHS:	Made by Order-Code

Drawing

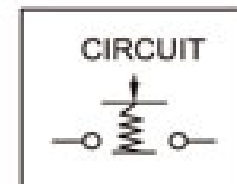
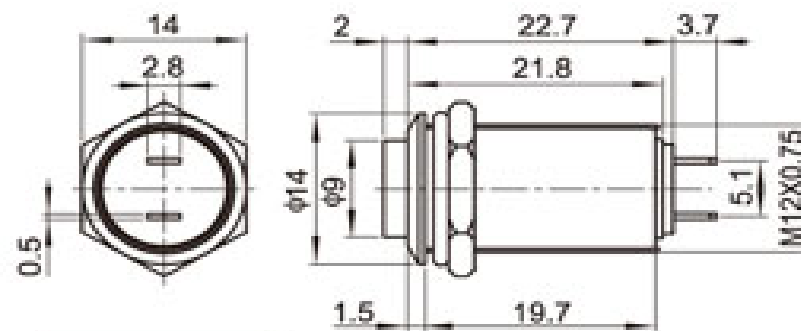

12MM Anti-Vandal-Switch

Part No.: **Q36059-**

Customer:

DRW:	Jason	CHKD	Wilson	MATL:	Wilson	TOLERANCE	Mason	DATE	18.06.2017
APPD:	Schumi			FINISH	Jamy		Sheet No.	1 from 3	

EDCON-COMPONENTS



Visual Effect of Surface



Nickel - plated brass
(Satin surface)



Stainless steel (Spiral surface)



Gold - plated brass (Satin surface)



G=Gray



B=Black



W=White

Engraving Options

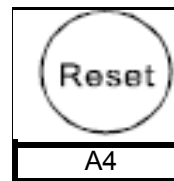

Order Code

A4

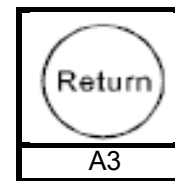

A3

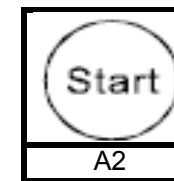

A2

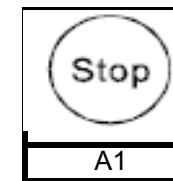

A1

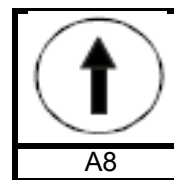

Order Code

A8

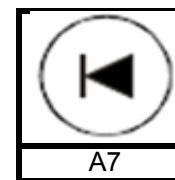

A7

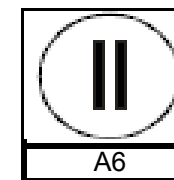

A6

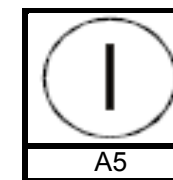

A5

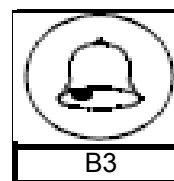

Order Code

B3

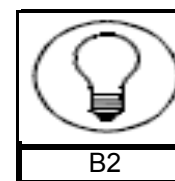

B2

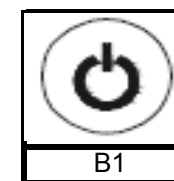

B1

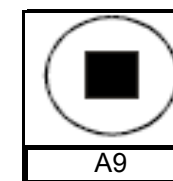

A9

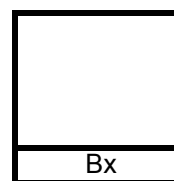

Order Code

Bx

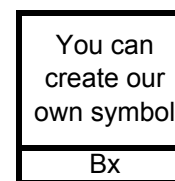

You can create our own symbol

Bx

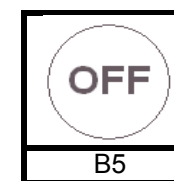

B5

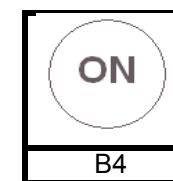

B4

12MM Anti-Vandal-Switch

Part No.: **Q36059-**

DRW:	Jason	CHKD	Wilson	MATL:	Wilson	TOLERANCE	Mason	DATE	18.06.2017	Customer:
APPD:	Schumi			FINISH	Jamy		Sheet No.		2 from 3	

EDCON-COMPONENTS



Ordering Information

Serie	Front Shape	Contact Structure	Lamp Type	Connect Type	Knob Color	Lamp Voltage	Crust Material	Engraving Options	ROHS	Packing Style
Q36059-	H	33	N	1	Y	0	N	XX	R	N

H= High		N= no Function	1= Solder Lug 2,0x0,5mm	A= Same us Body	0= without	S= Stainless Steel	XX= w/o other Look Order Code Engraving Options	R= ROHS Conform	N= NON ROHS Conform	N= White Carton
						N= Nickel Plated Brass				
						G= Gold Plated Brass				
		33= 1NO Self Locking								

12MM Anti-Vandal-Switch
Part No.: Q36059-
Customer:

DRW: Jason	CHKD Wilson	MATL: Wilson	TOLERANCE Mason	DATE 18.06.2017
APPD: Schumi		FINISH Jamy	Sheet No.	3 from 3